



OHMA[®] PIERCING CYLINDER PRODUCT GUIDE

Version 3.0

(WINDSOR) LIMITED

centerline®

OHMA® CYLINDER

THE OHMA® CYLINDER THE ORIGINAL

The OHMA® cylinder is a successful marriage of an air over fluid booster and cylinder. Its robust design remains one of the most practical and trouble-free systems available today.

By using shop air pressure and hydraulic fluid, the OHMA® cylinder produces work forces ranging from one ton to hundreds of tons. Rod, stroke and mounting style options make the OHMA® cylinder suitable for virtually all metalworking applications. The simple yet rugged construction can easily be customized for unique applications.

THE OHMA® ADVANTAGES

- A **low impact, fast approach stroke** to the work piece minimizes tool skidding, breakage & wear as well as part deformation.
- The **controllable force output** feature enables the OHMA® cylinder output force to be matched to the application.
- Its **compact construction** allows the cylinder to be easily positioned in confined work spaces.
- The OHMA® cylinder's method of operation **automatically compensates for variable part positions**. It strokes until it meets the work and then develops the necessary work force. Variable part positioning will not affect force output or power stroke distance when the part is within the cylinder's initial advance stroke range.
- The cylinder's small bore size uses a fraction of the air used by conventional pneumatic cylinders thus realizing substantial **savings in operating costs**.
- This **dependable, low maintenance system** has been designed for real world conditions. Its ease of use and control makes it the ideal choice for your next application.



APPLICATIONS

The OHMA® cylinder's many unique features are ideally suited for a variety of applications.

- **Piercing, Punching, Notching & Staking**

The low impact approach of the cylinder extends tool life. Built-in precision guidance often eliminates the need for tooling to be externally guided. Incorporating the OHMA® cylinder on existing tools can eliminate the need for complete die replacement if the part design is altered.

- **Self-piercing Rivets & Nuts**

With the OHMA® cylinder, rivets and nuts are gently pushed through the material to obtain highly consistent results. Under low impact closure, the rivet or nut is allowed to adjust its position between tooling and part.

- **Clinching**

The squeeze action eliminates the tearing effect associated with clinching; the result is a strong joint which can often be used as an alternative to riveting or welding.

- **Tube Flaring & Bending**

The delicate power stroke controls splitting and allows the cylinder to form the tube with minimal defects.

- **Marking & Coining**

The OHMA® cylinder can easily adapt to the variables that affect mechanical marking and coining presses and tooling. Since the force is delivered constantly over the entire power stroke, the material can have time to flow. This expands the range of material that can be marked/coined and improves the results.

This brochure identifies the standard OHMA® piercing cylinder styles and complementary products. Contact CenterLine (Windsor) Limited directly or its distributor to receive information concerning OHMA® weld cylinders, slide packages, air cylinders & boosters.



centerline®

OHMA® CYLINDER

OHMA® Features & Benefits

The OHMA® Cylinder Advantages

Innovative product design and attention to manufacturing detail are reflected in the OHMA® cylinder system.

- **ABILITY TO FUNCTION IN ANY POSITION**

A convenient, remote fluid reservoir supplies fluid to the OHMA® cylinder. This allows the cylinder to operate in any orientation without adversely affecting its ability to intensify. In most applications, any air which might enter the system will naturally be bled after one or two cycles. In extreme situations where the cylinder is installed in the inverted position, contact CenterLine to discuss the proper bleeding procedure. The fluid supply can be easily replenished by adding fluid to the reservoir rather than at the cylinder. With the OHMA® cylinder, the application dictates its position... not the cylinder.

- **COMPACT & EFFICIENT**

The compact size of the OHMA® cylinder results in substantial savings in air consumption. Compact machine designs can be developed to take advantage of the OHMA® cylinder's small physical size thus realizing further savings (i.e. reduced frame size, shorter supply lines, etc.).

- **EXTENSIVE FORCE RANGE**

The OHMA® cylinder can be adjusted to produce a broad range of force outputs. This allows the cylinder to accommodate a variety of applications and simplifies re-tooling for new and short run work. In the event that material specifications are changed, the OHMA® cylinder can be adjusted to compensate for new application parameters.

- **DESIGN OPTIONS**

Recognizing that many applications are unique, CenterLine can manufacture custom OHMA® cylinders to suit specific applications. Custom ratios, power strokes, total strokes, and rod end styles, can normally be accommodated to maximize process efficiencies. Centerline has the experience and the capabilities needed to recommend a custom OHMA® cylinder style.

- **LOW IMPACT**

The OHMA® cylinder's low impact advance stroke results in prolonged tooling life, reduced part deformation, and decreased overall shock to the equipment. Many applications, such as riveting, clinching, and tube flaring, enjoy superior part quality due to this low impact approach. An added benefit is the reduction in noise produced when operating the OHMA® cylinder.

- **CONSISTENT FORCE PRODUCTION**

Variable part positioning has no effect on the force generated by the OHMA® cylinder; as long as the part is positioned within the cylinder's low pressure advance stroke range (total stroke minus power stroke), the OHMA® cylinder will produce a consistent force and power stroke.

- **SIMPLE CONSTRUCTION AND OPERATION**

With only two moving parts, the OHMA® cylinder is easy to install and operate. The simple design of the OHMA® cylinder is easily serviceable to keep downtime to a minimum.

- **DEPENDABILITY**

The OHMA® cylinder is a proven product. Its rugged, dependable, construction is intended for long term, demanding applications. With a program of routine preventative maintenance, the OHMA® cylinder will provide reliable, trouble-free operation for years to come.



TABLE OF CONTENTS



Section A

Cylinder Components	A-1
Sequence of Operation & System Requirements	A-2
Cylinder Operating Characteristics	A-3
Cylinder Selection	A-4

Section B

Piercing Cylinder Specifications	B-1 – B-16
----------------------------------	------------

Section C

ISO & ASB Fluid Reservoirs	C-1 – C-3
Standard Fluid Reservoirs	C-4 – C-6
Standard Configuration & “Delicate Touch” Option Hook-up	C-7
Pneumatic Schematics	C-8

Section D

Operating Instructions	D-1
Unique Cylinder Styles & Options	D-1, D-2

PIERCING CYLINDERS

Cylinder Components

The fluid source used to operate the OHMA® cylinder is supplied from a remote mounted **Fluid Reservoir**. CenterLine manufactures three styles of reservoir packages. All reservoirs are manufactured to provide superior baffling to reduce fluid agitation and aeration and incorporate a translucent fiberglass barrel so that fluid level and the presence of contaminants can be easily monitored. The fluid requirement of the OHMA® cylinder represents the volume of fluid needed to properly sequence the OHMA® cylinder. Following the reservoir sizing guidelines on pages C-2 to C-6 will ensure that the OHMA® cylinder is matched with a reservoir which has the proper capacity to supply the cylinder with its fluid requirement.

The **High Pressure Seal** is a high quality urethane lip type seal which withstands the high pressure developed in the cylinder.

The block which divides the intensifier and working sections of the cylinder is the **Middle Separator**. This block contains the cylinder's high pressure seal and serves as the entry point of the fluid into the cylinder.

The **Manifold** is an external tube which provides a path for the return air pressure used to retract both the working & intensifier pistons.

The cylinder **Front Block** provides guidance for the working piston stroke and serves as the cylinder's mounting surface. There are 2 styles of Front Blocks available: Front Flange (CFF), and Front Block (FBL).

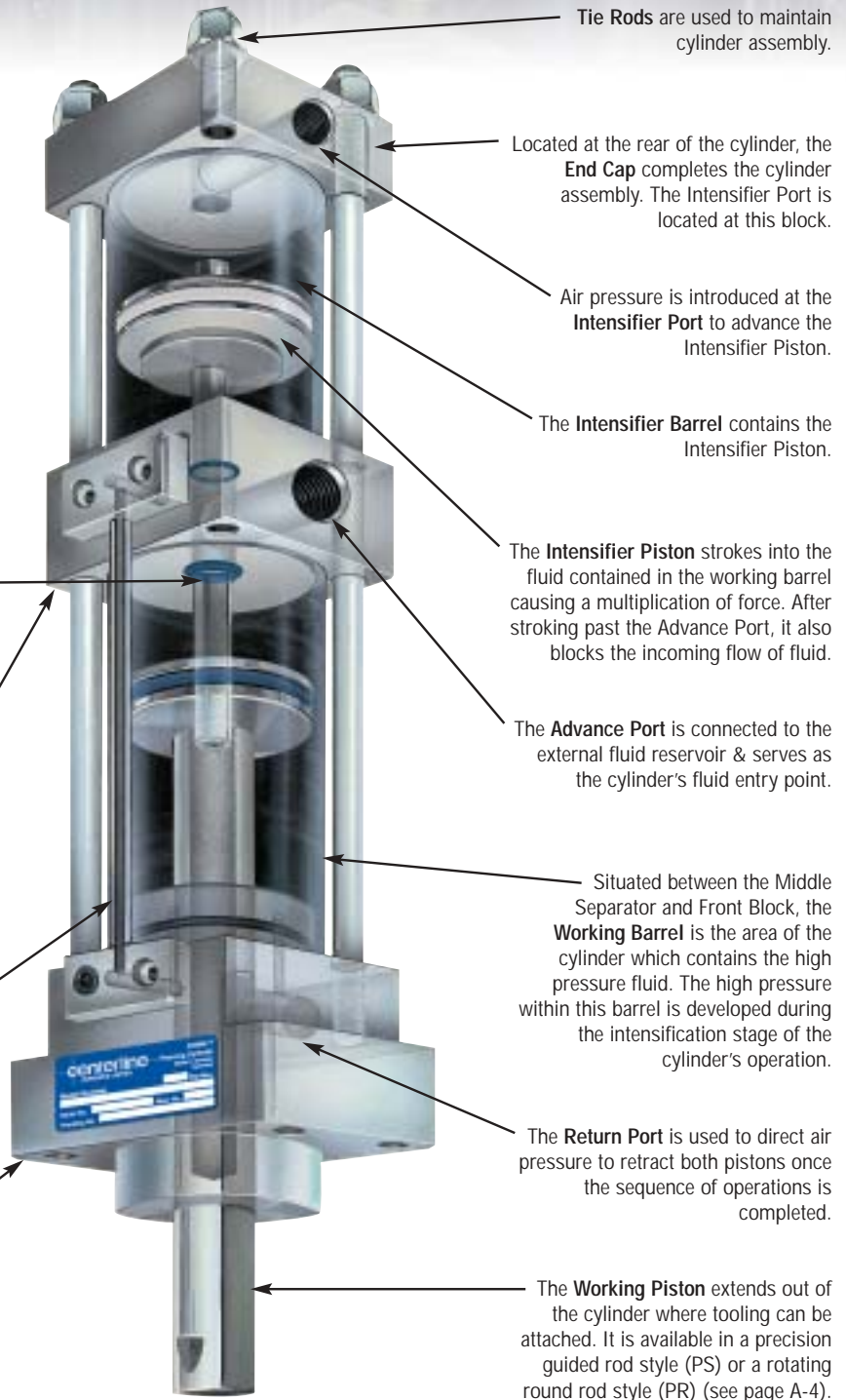

Tie Rods are used to maintain cylinder assembly.

Located at the rear of the cylinder, the **End Cap** completes the cylinder assembly. The **Intensifier Port** is located at this block.

Air pressure is introduced at the **Intensifier Port** to advance the **Intensifier Piston**.

The **Intensifier Barrel** contains the **Intensifier Piston**.

The **Intensifier Piston** strokes into the fluid contained in the working barrel causing a multiplication of force. After stroking past the **Advance Port**, it also blocks the incoming flow of fluid.

The **Advance Port** is connected to the external fluid reservoir & serves as the cylinder's fluid entry point.

Situated between the **Middle Separator** and **Front Block**, the **Working Barrel** is the area of the cylinder which contains the high pressure fluid. The high pressure within this barrel is developed during the intensification stage of the cylinder's operation.

The **Return Port** is used to direct air pressure to retract both pistons once the sequence of operations is completed.

The **Working Piston** extends out of the cylinder where tooling can be attached. It is available in a precision guided rod style (PS) or a rotating round rod style (PR) (see page A-4).

For illustration purposes, port positions have been altered. Consult the technical specifications in Section B for actual positions.

The OHMA® Cylinder is a patented product. CenterLine (Windsor) Limited reserves the right to change specifications.

PIERCING CYLINDERS

Sequence of Operation & System Requirements

The OHMA® Cylinder Sequence of Operation

(Refer to page A-1 for description of cylinder components)

1. Cylinder At Rest Position

In this view, line pressure (air) is directed to Port EE1 (Return Port) to maintain the working and intensifier pistons in a retracted position. Port EE3 (Intensifier Port) and the fluid reservoir are vented to atmosphere.

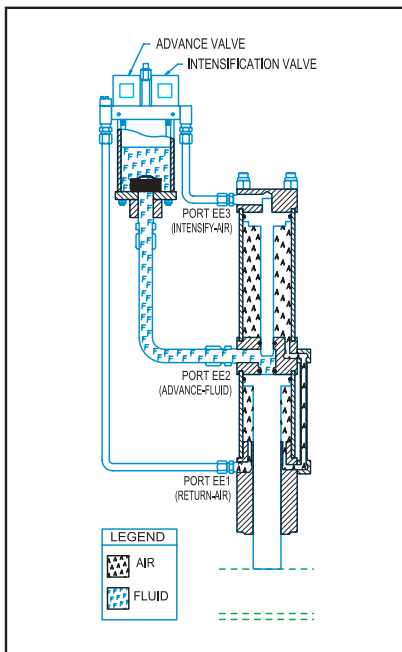

Figure 1

2. Low Pressure Advance Stroke

During the first stage of the cylinder's operation, air pressure is directed to the top of the fluid reservoir to move fluid into the OHMA® cylinder via Port EE2 (Advance Port). The low pressure fluid causes the working piston to stroke forward and meet the work at low impact. Ports EE1 and EE3 are vented to atmosphere.

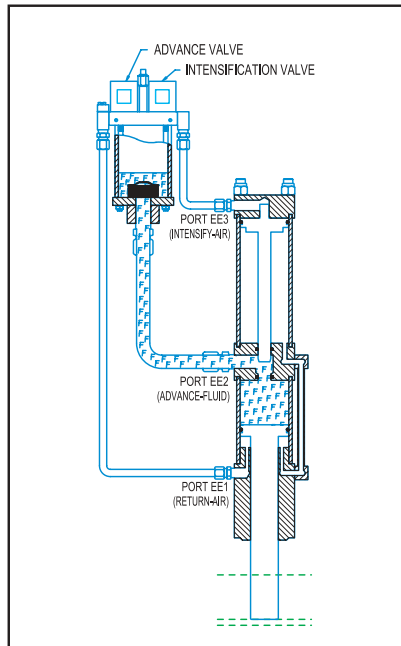

Figure 2

3. Power Stroke

Regulated air pressure is applied to Port EE3 to drive the intensifier piston forward. This piston advances through the middle separator to block all incoming fluid at Port EE2 and seal the OHMA® cylinder fluid chamber. As the intensifier piston strokes into the fluid, trapped fluid is displaced to produce the power stroke.

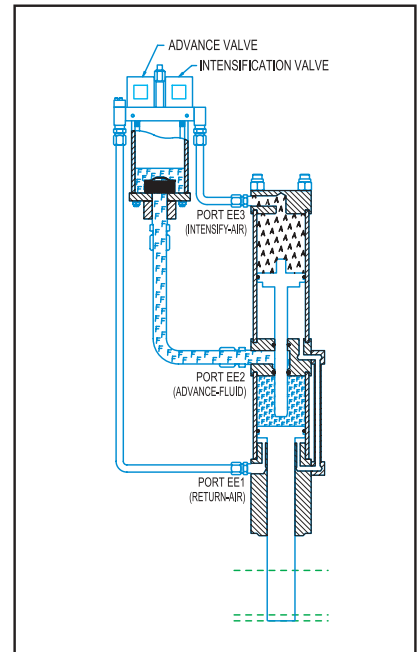

Figure 3

4. Return Stroke

Once the work is complete, air pressure is again directed to Port EE1. This causes the pistons to return to their rest position.

Minimum System Requirements

Refer to pages C-7 to C-8 for hook-up instructions.

The following items must be provided in order to properly operate an OHMA® cylinder:

- 1 Fluid Reservoir or a compatible substitute
- 2 Four-way Valves or 1-Three-way Valve & 1-Four-way Valve
NOTE: Valves are incorporated with ISO and ASB OHMA® reservoirs. Valves to be dual pressure capable and configured for external pilot.
- 1 5 Micron Filter (or 5 Micron Coalescent Filter)
NOTE: In a pneumatic supply environment with high contaminants or water content, a coalescent filter or a reclassifier is recommended.
- 1 Regulator
- Fluid as per CenterLine recommendations or equivalent.
- A method of independently sequencing the two valves to produce the desired sequence of operation. This can normally be achieved with the use of two timers. Contact CenterLine for additional control information.

The OHMA® Cylinder is a patented product. CenterLine (Windsor) Limited reserves the right to change specifications.

PIERCING CYLINDERS

Cylinder Operating Characteristics

Following is a brief explanation of the unique operating characteristics of the OHMA® cylinder which are mentioned throughout this catalogue.

RATIO

The OHMA® cylinder functions on an intensification principle to boost air pressure by a set factor, **the ratio**. This ratio feature, allows the OHMA® cylinder to produce a wide range of force outputs within a given cylinder design. For example, a 156:1 ratio OHMA® cylinder operating at 65 psi will produce a force output of 10,140 lbs (156 x 65). Adjusting the air pressure to 45 psi will result in the cylinder producing 7,020 lbs (156 x 45) of force.

TOTAL STROKE LIMIT

The two stage operation of the OHMA® cylinder produces three distinct classifications of stroke; the **advance stroke**, the **power stroke**, and the **return stroke**. The total stroke limit is the maximum distance the working piston is able to travel.

Advance Stroke

The distance which the working piston initially travels to reach the work is referred to as the **advance stroke**. During this stage, the cylinder contacts the work with minimal impact; the force at which the working piston strikes the work is referred to as the **advance force**. This force may also be referred to as the **soft touch approach**.

Power Stroke

The force produced by the OHMA® cylinder is transferred to the work by means of the **power stroke** or intensification stroke. The power stroke represents the distance that the cylinder working piston travels once the cylinder has been intensified. Each OHMA® cylinder is designed to produce a fixed power stroke. The power stroke must be longer than the length of high pressure travel needed to perform the application. In some applications multiple power strokes may be applied to accommodate longer power stroke requirements.

Return Stroke

The retract portion of the cycle is called the **return stroke**. The force with which the cylinder retracts is specified as the **return force**. Since the return force is not multiplied and the OHMA® cylinders are designed with relatively small bore sizes, high return forces are not generated. To ensure that there will be sufficient return force, tooling weight and stripping force must be considered when choosing a particular OHMA® cylinder.

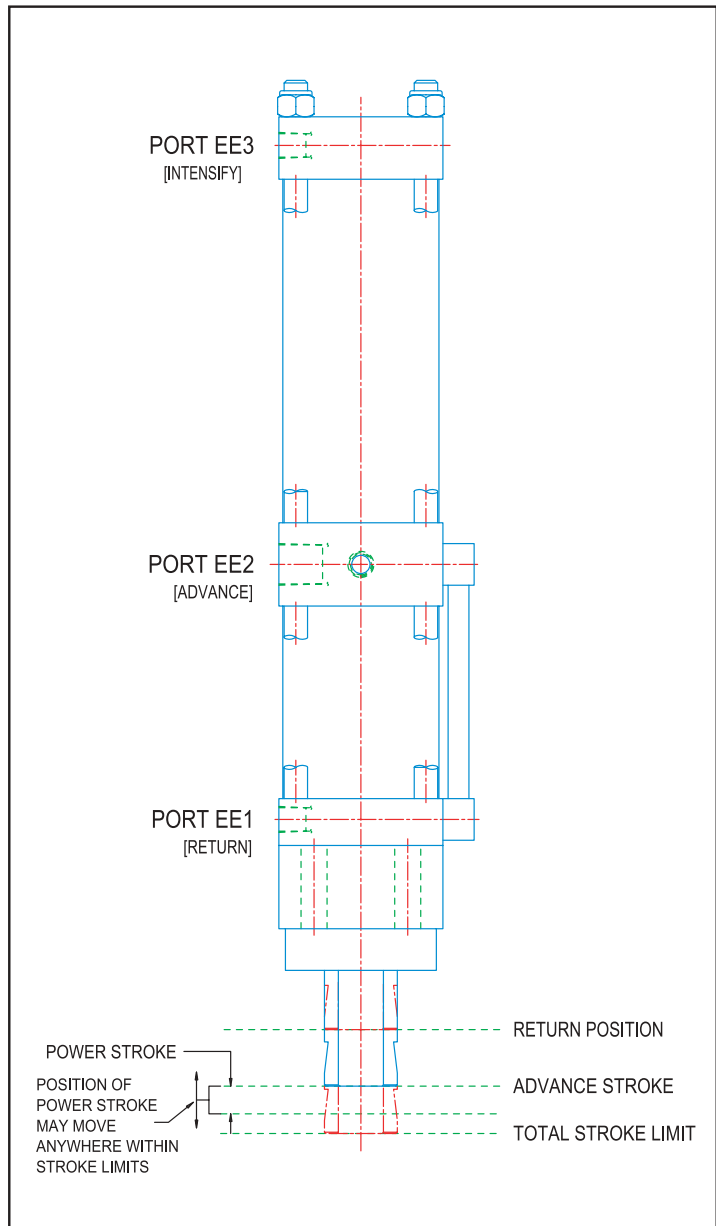

The OHMA® Cylinder is a patented product. CenterLine (Windsor) Limited reserves the right to change specifications.

PIERCING CYLINDERS

Cylinder Selection

The OHMA® cylinders are available with a number of options to satisfy a variety of applications. To choose a proper OHMA® cylinder, follow the step by step instructions below.		Example																																				
Step 1	Determine the required force and the operating air pressure to be used for the application.	Required Force is 18,000 lbs Operating Air Pressure is 65 psi																																				
Step 2	<p>Calculate the application force ratio: divide the required force by the operating air pressure.</p> <p>Choose a standard cylinder ratio with the next highest value. The chart below indicates the standard OHMA® cylinder ratios.</p> <table border="1"> <thead> <tr> <th>RATIOS</th> <th>BORE</th> <th>MOUNTING STYLE</th> <th>PAGE</th> </tr> </thead> <tbody> <tr> <td>32:1 & 50:1</td> <td>2"</td> <td>FF, FBL</td> <td>B-2</td> </tr> <tr> <td>79:1 & 95:1</td> <td>2-5/8"</td> <td>CFF, FBL</td> <td>B-4</td> </tr> <tr> <td>156:1 & 224:1</td> <td>3-1/4"</td> <td>CFF, FBL</td> <td>B-6</td> </tr> <tr> <td>262:1 & 300:1</td> <td>4"</td> <td>CFF, FBL</td> <td>B-8</td> </tr> <tr> <td>387:1</td> <td>5"</td> <td>CFF, FBL</td> <td>B-10</td> </tr> <tr> <td>538:1</td> <td>6"</td> <td>CFF, FBL</td> <td>B-12</td> </tr> <tr> <td>800:1</td> <td>6"</td> <td>CFF, FBL</td> <td>B-14</td> </tr> <tr> <td>1430:1 & 1700:1</td> <td>8"</td> <td>CFF</td> <td>B-16</td> </tr> </tbody> </table> <p>Refer to the cylinder chart outlining the available models for the chosen ratio and select the mounting style best suited to the application.</p>	RATIOS	BORE	MOUNTING STYLE	PAGE	32:1 & 50:1	2"	FF, FBL	B-2	79:1 & 95:1	2-5/8"	CFF, FBL	B-4	156:1 & 224:1	3-1/4"	CFF, FBL	B-6	262:1 & 300:1	4"	CFF, FBL	B-8	387:1	5"	CFF, FBL	B-10	538:1	6"	CFF, FBL	B-12	800:1	6"	CFF, FBL	B-14	1430:1 & 1700:1	8"	CFF	B-16	<p>Application Force Ratio = 18000 lbs/65 psi = 276.9 : 1</p> <p>∴ Select a cylinder with a 300:1 ratio.</p> <p>Mounting Style: Front Flange (CFF)</p>
RATIOS	BORE	MOUNTING STYLE	PAGE																																			
32:1 & 50:1	2"	FF, FBL	B-2																																			
79:1 & 95:1	2-5/8"	CFF, FBL	B-4																																			
156:1 & 224:1	3-1/4"	CFF, FBL	B-6																																			
262:1 & 300:1	4"	CFF, FBL	B-8																																			
387:1	5"	CFF, FBL	B-10																																			
538:1	6"	CFF, FBL	B-12																																			
800:1	6"	CFF, FBL	B-14																																			
1430:1 & 1700:1	8"	CFF	B-16																																			
Step 3	<p>Decide which working piston rod style to use. There are two styles available: Precision Guided Rod (PS) or Rotating Round Rod (PR).</p> <p>Contact CenterLine for custom rod end styles.</p> <p>The "PS" cylinders are manufactured with a precision guided non-rotating rod which is fitted to close tolerances. The close tolerance fit normally provides sufficient guidance for tooling which is situated at the centre of the rod.</p> <p>The "PR" cylinders are manufactured with a rotating round rod. This style is normally used when the application does not require guidance or where external guidance is present.</p>	<p>Rod Style: Precision Guided (PS)</p>																																				
Step 4	<p>Determine the power stroke and advance stroke needed to perform the application.</p> <p>Guidelines:</p> <ul style="list-style-type: none"> -the cylinder power stroke must be greater than the stroke required to complete the application. -choose the total stroke so that the sum of the advance stroke and the power stroke exceeds the distance from the tooling to the work. (This will ensure that the cylinder will not bottom-out.) -there must be sufficient stroke to accommodate tooling wear. <p>Total Stroke = Power Stroke + Advance Stroke (See page A-3 for a detailed definition of each stroke.)</p>	<p>Required Power Stroke .25"</p> <p>Required Advance Stroke is 3.75"</p> <p>Required Total Stroke is 4.0"</p> <p>∴ Selected Total Stroke is 6"</p> <p>∴ Selected Power Stroke is .29"</p>																																				
Step 5	<p>Using the features determined in Steps 2, 3, & 4, select the proper OHMA® cylinder model from the chart.</p> <p>The technical specifications page will provide the physical dimensions of the cylinder.</p>	<p>Cylinder model for this application: PS816-300-CFF-.29-TR-24Z3</p>																																				
Step 6	Select a proper Fluid Reservoir by referring to Section C.																																					

The OHMA® Cylinder is a patented product. CenterLine (Windsor) Limited reserves the right to change specifications.

PIERCING CYLINDERS

2" Bore, 32:1 and 50:1 Ratio - Technical Specifications

BARREL ASSEMBLY

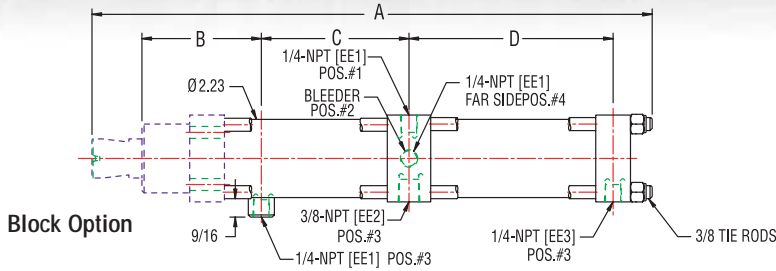

EE1 - RETURN PORT (AIR) EE2- ADVANCE PORT (FLUID) EE3- INTENSIFIER PORT (AIR)

PORT POSITION DESIGNATION

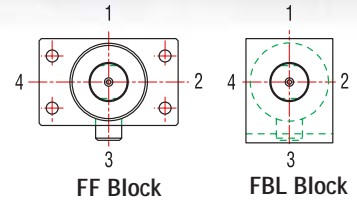

Front View

FRONT FLANGE MOUNTING STYLE (FF)

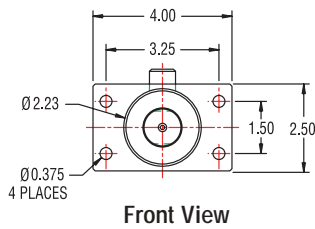

Front View

PR Construction

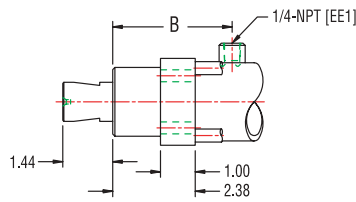

ROD END STYLE DESIGNATION

Rotating Round Rod (PR)

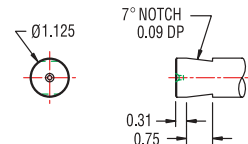

PS Construction

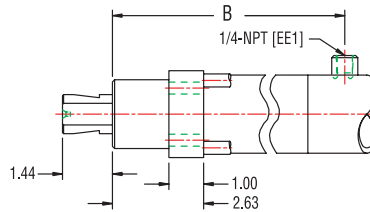

Precision Guided Rod (PS)

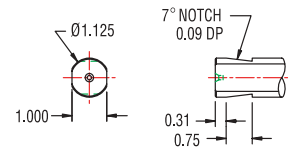

Typical Mounting Configuration

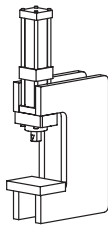

FRONT BLOCK MOUNTING STYLE (FBL)

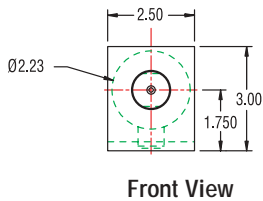

Front View

PR Construction

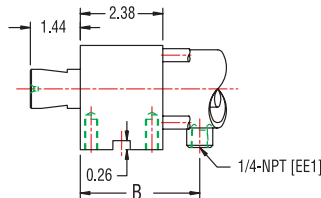

PS Construction

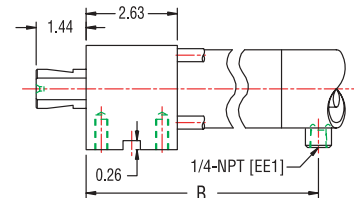

Typical Mounting Configuration

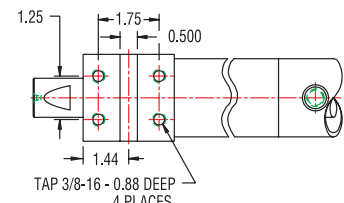
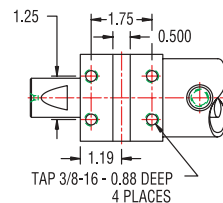
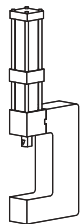

Rod end style, port location, total stroke, ratio and power stroke modifications are available upon request. For details, consult CenterLine® Automation Components Division.

The OHMA® Cylinder is a patented product. CenterLine (Windsor) Limited reserves the right to change specifications.

PIERCING CYLINDERS

2" Bore, 32:1 and 50:1 Ratio - Dimensional Specifications

Total Stroke (in.)	Power Stroke (in.)		Block Type	"A"	"B"	"C"	"D"	Fluid Req'd (cu. in.)	Model Number	
	32:1	50:1		(in.)	(in.)	(in.)	(in.)		32:1 Ratio	50:1 Ratio
ROTATING ROUND ROD STYLES (PR)										
3	.34	.22	PR	17-1/16	3-9/16	4-1/2	6-1/8	9	PR88-32- * -.34-TR-12Z3	PR88-50- * -.22-TR-12Z3
3	.50	.32	PR	18-9/16	3-9/16	4-1/2	7-11/16	9	PR88-32- * -.50-TR-12Z3	PR88-50- * -.32-TR-12Z3
6	.34	.22	PR	20-1/16	3-9/16	7-1/2	6-1/8	19	PR88-32- * -.34-TR-24Z3	PR88-50- * -.22-TR-24Z3
6	.50	.32	PR	21-9/16	3-9/16	7-1/2	7-11/16	19	PR88-32- * -.50-TR-24Z3	PR88-50- * -.32-TR-24Z3
6	.75	N/A	PR	24-1/8	3-9/16	7-1/2	10-1/4	19	PR88-32- * -.75-TR-24Z3	NOT AVAILABLE
8	.34	.22	PR	22-1/16	3-9/16	9-1/2	6-1/8	25	PR88-32- * -.34-TR-32Z3	PR88-50- * -.22-TR-32Z3
8	.50	.32	PR	23-9/16	3-9/16	9-1/2	7-11/16	25	PR88-32- * -.50-TR-32Z3	PR88-50- * -.32-TR-32Z3
8	.75	N/A	PR	26-1/8	3-9/16	9-1/2	10-1/4	25	PR88-32- * -.75-TR-32Z3	NOT AVAILABLE
PRECISION GUIDED ROD STYLES (PS)										
3	.34	.22	PS	17-5/16	3-13/16	4-1/2	6-1/8	9	PS88-32- * -.34-TR-12Z3	PS88-50- * -.22-TR-12Z3
3	.50	.32	PS	18-13/16	3-13/16	4-1/2	7-11/16	9	PS88-32- * -.50-TR-12Z3	PS88-50- * -.32-TR-12Z3
6	.34	.22	PS	23-5/16	6-13/16	7-1/2	6-1/8	19	PS88-32- * -.34-TR-24Z3	PS88-50- * -.22-TR-24Z3
6	.50	.32	PS	24-13/16	6-13/16	7-1/2	7-11/16	19	PS88-32- * -.50-TR-24Z3	PS88-50- * -.32-TR-24Z3
6	.75	N/A	PS	27-3/8	6-13/16	7-1/2	10-1/4	19	PS88-32- * -.75-TR-24Z3	NOT AVAILABLE
8	.34	.22	PS	27-5/16	8-13/16	9-1/2	6-1/8	25	PS88-32- * -.34-TR-32Z3	PS88-50- * -.22-TR-32Z3
8	.50	.32	PS	28-13/16	8-13/16	9-1/2	7-11/16	25	PS88-32- * -.50-TR-32Z3	PS88-50- * -.32-TR-32Z3
8	.75	N/A	PS	31-3/8	8-13/16	9-1/2	10-1/4	25	PS88-32- * -.75-TR-32Z3	NOT AVAILABLE

* Replace with "FF" for Front Flange mounting or "FBL" for Front Block mounting.

FEATURES:	32:1	50:1
Maximum Advance Force-using 100 psi (lbs)	310	310
Maximum Return Force-using 100 psi (lbs)	210	210
Force Output Range using 20-100 psi (lbs)	640-3200	1000-5000
EE1 Return Port-air (NPT)	1/4	1/4
EE2 Advance Port-fluid (NPT)	3/8	3/8
EE3 Intensifier Port-air (NPT)	1/4	1/4

MODEL NUMBER BREAKDOWN

PR 8 8 - 32 - FF - .34 - TR - 12

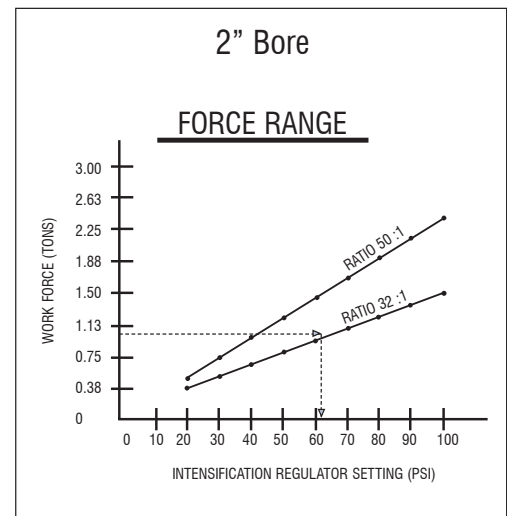
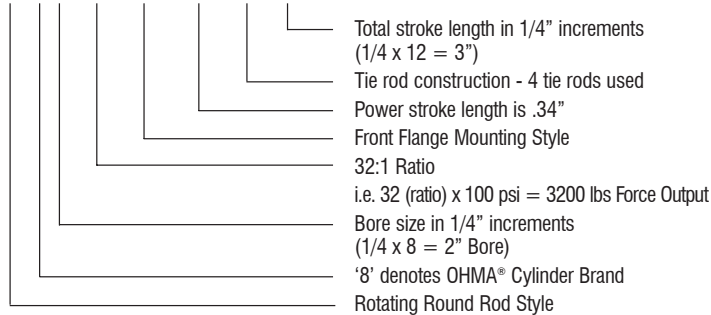

Example: 1.0 ton work force requires a 63 psi regulator setting with a 32:1 ratio cylinder.

Note: Seal friction and standard manufacturing tolerances may reduce the effective OHMA® cylinder ratio by approximately 5-10%. Contact CenterLine for additional information.

Rod end style, port location, total stroke, ratio and power stroke modifications are available upon request. For details, consult CenterLine® Automation Components Division.

The OHMA® Cylinder is a patented product. CenterLine (Windsor) Limited reserves the right to change specifications.

PIERCING CYLINDERS

2-5/8" Bore, 79:1 and 95:1 Ratio - Technical Specifications

BARREL ASSEMBLY

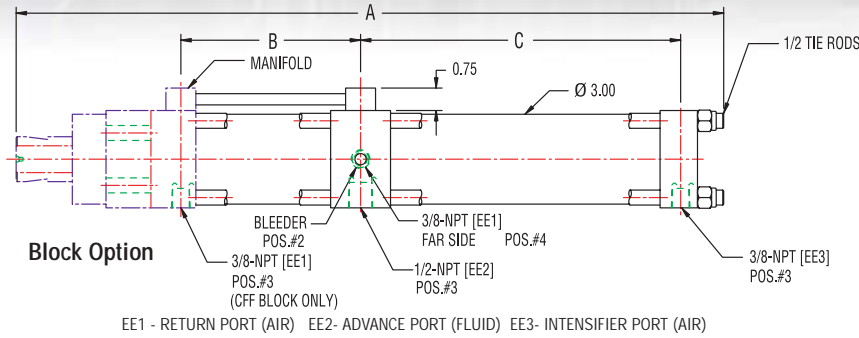

PORT POSITION DESIGNATION

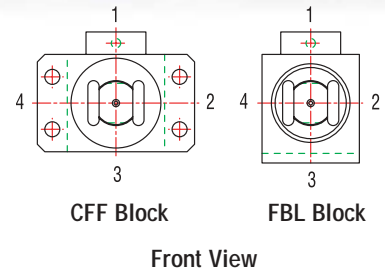

FRONT FLANGE MOUNTING STYLE (CFF)

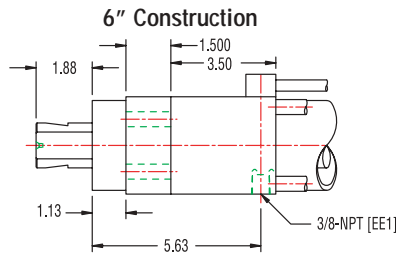
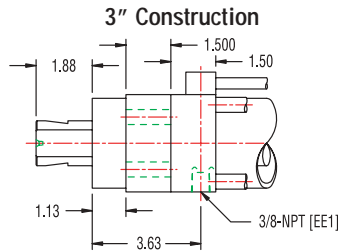
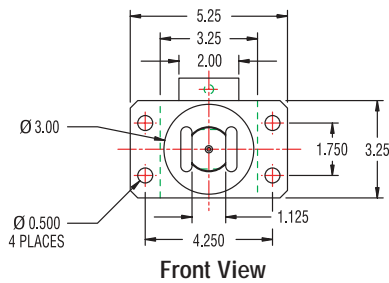

Typical Mounting Configuration

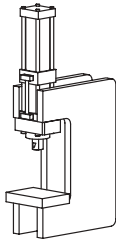

ROD END STYLE DESIGNATION

Rotating Round Rod (PR)

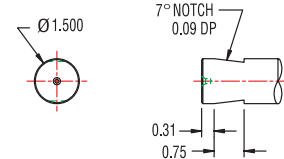

Precision Guided Rod (PS)

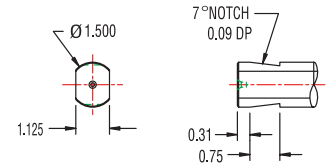

FRONT BLOCK MOUNTING STYLE (FBL)

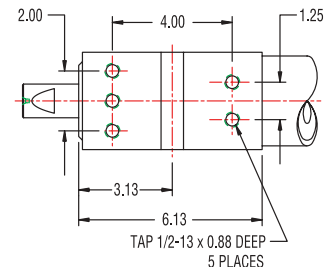
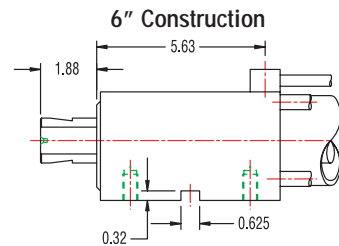
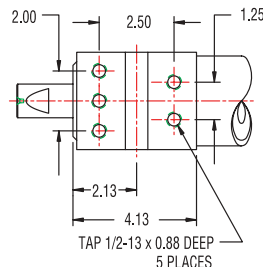
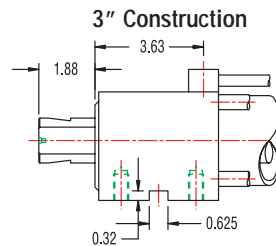
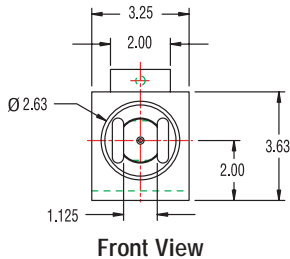

Typical Mounting Configuration

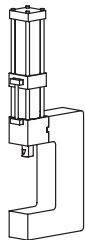

Rod end style, port location, total stroke, ratio and power stroke modifications are available upon request. For details, consult CenterLine® Automation Components Division.

The OHMA® Cylinder is a patented product. CenterLine (Windsor) Limited reserves the right to change specifications.

PIERCING CYLINDERS

2-5/8" Bore, 79:1 and 95:1 Ratio - Dimensional Specifications

Total Stroke (in.)	Power Stroke (in.)		Block Type (in.)	"A" (in.)	"B" (in.)	"C" (in.)	Fluid Req'd (cu. in.)	Model Number	
	79:1	95:1						79:1 Ratio	95:1 Ratio
ROTATING ROUND ROD STYLES (PR)									
3	.34	.28	3	21-3/8	6	8-7/16	16	PR8105-79- * -.34-TR-12Z3	PR8105-95- * -.28-TR-12Z3
3	.50	.41	3	23-5/8	6	10-11/16	16	PR8105-79- * -.50-TR-12Z3	PR8105-95- * -.41-TR-12Z3
6	.34	.28	6	27	9-5/8	8-7/16	32	PR8105-79- * -.34-TR-24Z3	PR8105-95- * -.28-TR-24Z3
6	.50	.41	6	29-1/4	9-5/8	10-11/16	32	PR8105-79- * -.50-TR-24Z3	PR8105-95- * -.41-TR-24Z3
6	.75	.61	6	32-7/8	9-5/8	14-5/16	32	PR8105-79- * -.75-TR-24Z3	PR8105-95- * -.61-TR-24Z3
8	.34	.28	3	26-3/8	11	8-7/16	43	PR8105-79- * -.34-TR-32Z3	PR8105-95- * -.28-TR-32Z3
8	.50	.41	3	28-5/8	11	10-11/16	43	PR8105-79- * -.50-TR-32Z3	PR8105-95- * -.41-TR-32Z3
8	.75	.61	3	32-1/4	11	14-5/16	43	PR8105-79- * -.75-TR-32Z3	PR8105-95- * -.61-TR-32Z3
PRECISION GUIDED ROD STYLES (PS)									
3	.34	.28	3	21-3/8	6	8-7/16	16	PS8105-79- * -.34-TR-12Z3	PS8105-95- * -.28-TR-12Z3
3	.50	.41	3	23-5/8	6	10-11/16	16	PS8105-79- * -.50-TR-12Z3	PS8105-95- * -.41-TR-12Z3
6	.34	.28	6	27	9-5/8	8-7/16	32	PS8105-79- * -.34-TR-24Z3	PS8105-95- * -.28-TR-24Z3
6	.50	.41	6	29-1/4	9-5/8	10-11/16	32	PS8105-79- * -.50-TR-24Z3	PS8105-95- * -.41-TR-24Z3
6	.75	.61	6	32-7/8	9-5/8	14-5/16	32	PS8105-79- * -.75-TR-24Z3	PS8105-95- * -.61-TR-24Z3
8	.34	.28	6	31	13-5/8	8-7/16	43	PS8105-79- * -.34-TR-32Z3	PS8105-95- * -.28-TR-32Z3
8	.50	.41	6	33-1/4	13-5/8	10-11/16	43	PS8105-79- * -.50-TR-32Z3	PS8105-95- * -.41-TR-32Z3
8	.75	.61	6	36-7/8	13-5/8	14-5/16	43	PS8105-79- * -.75-TR-32Z3	PS8105-95- * -.61-TR-32Z3

* Replace with "CFF" for Front Flange mounting or "FBL" for Front Block mounting.

FEATURES:	79:1	95:1
Maximum Advance Force-using 100 psi (lbs)	540	540
Maximum Return Force-using 100 psi (lbs)	360	360
Force Output Range using 20-100 psi (lbs)	1580-7900	1900-9500
EE1 Return Port-air (NPT)	3/8	3/8
EE2 Advance Port-fluid (NPT)	1/2	1/2
EE3 Intensifier Port-air (NPT)	3/8	3/8

MODEL NUMBER BREAKDOWN

PS 8 105 - 79 - FBL - .50 - TR - 24Z3

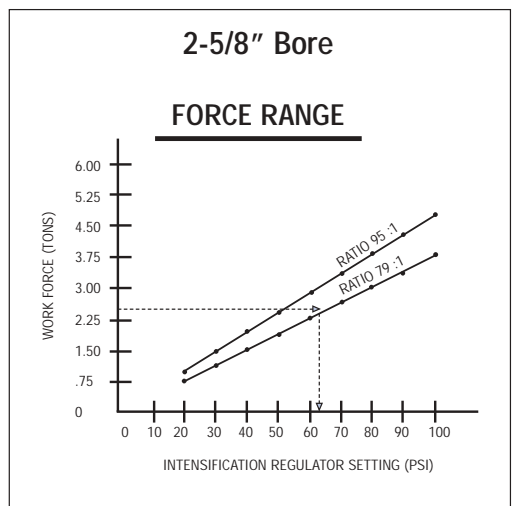
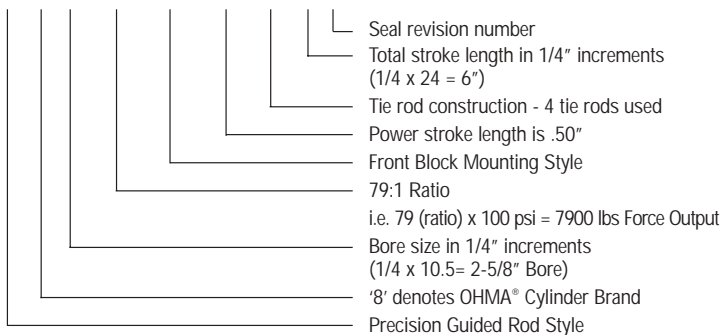

Example: 2.5 tons work force requires a 63 psi regulator setting with a 79:1 ratio cylinder.

Note: Seal friction and standard manufacturing tolerances may reduce the effective OHMA® cylinder ratio by approximately 5-10%. Contact CenterLine for additional information.

Rod end style, port location, total stroke, ratio and power stroke modifications are available upon request. For details, consult CenterLine® Automation Components Division.

The OHMA® Cylinder is a patented product. CenterLine (Windsor) Limited reserves the right to change specifications.

PIERCING CYLINDERS

3-1/4" Bore, 156:1 and 224:1 Ratio - Technical Specifications

BARREL ASSEMBLY

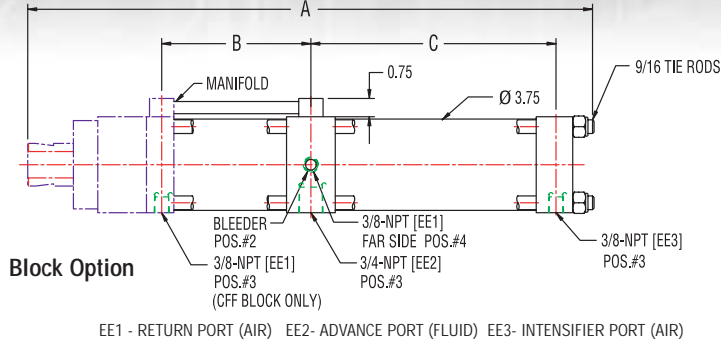

PORT POSITION DESIGNATION

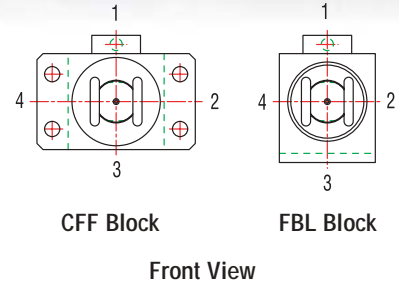

FRONT FLANGE MOUNTING STYLE (CFF)

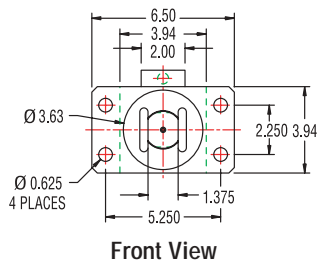

Typical Mounting Configuration

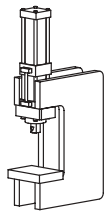

3" Construction

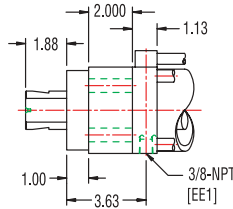

6" Construction

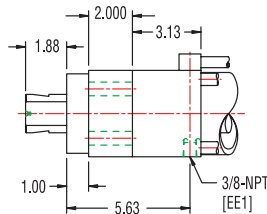

ROD END STYLE DESIGNATION

Rotating Round Rod (PR)

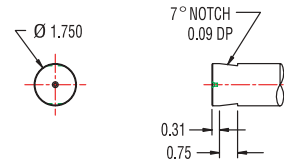

Precision Guided Rod (PS)

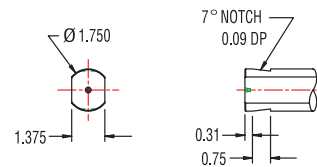

FRONT BLOCK MOUNTING STYLE (FBL)

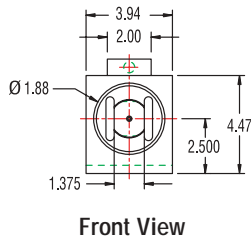

Typical Mounting Configuration

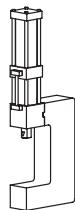

3" Construction

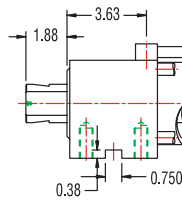

6" Construction

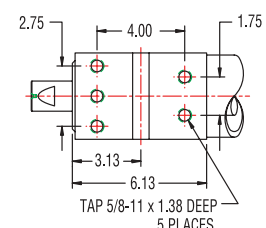
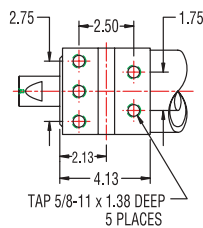
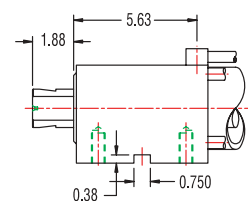

Rod end style, port location, total stroke, ratio and power stroke modifications are available upon request. For details, consult CenterLine® Automation Components Division.

The OHMA® Cylinder is a patented product. CenterLine (Windsor) Limited reserves the right to change specifications.

PIERCING CYLINDERS

3-1/4" Bore, 156:1 and 224:1 Ratio - Dimensional Specifications

Total Stroke (in.)	Power Stroke (in.)		Block Type (in.)	"A" (in.)	"B" (in.)	"C" (in.)	Fluid Req'd (cu. in.)	Model Number	
	156:1	224:1						156:1 Ratio	224:1 Ratio
ROTATING ROUND ROD STYLES (PR)									
3	.34	.23	3	23-1/4	6-1/8	10-1/16	25	PR813-156- * -.34-TR-12Z3	PR813-224- * -.23-TR-12Z3
3	.50	.34	3	26-1/4	6-1/8	13-1/16	25	PR813-156- * -.50-TR-12Z3	PR813-224- * -.34-TR-12Z3
6	.34	.23	6	28-7/8	9-3/4	10-1/16	50	PR813-156- * -.34-TR-24Z3	PR813-224- * -.23-TR-24Z3
6	.50	.34	6	31-7/8	9-3/4	13-1/16	50	PR813-156- * -.50-TR-24Z3	PR813-224- * -.34-TR-24Z3
6	.75	N/A	6	36-5/8	9-3/4	17-13/16	50	PR813-156- * -.75-TR-24Z3	NOT AVAILABLE
8	.34	.23	3	28-1/4	11-1/8	10-1/16	66	PR813-156- * -.34-TR-32Z3	PR813-224- * -.23-TR-32Z3
8	.50	.34	3	31-1/4	11-1/8	13-1/16	66	PR813-156- * -.50-TR-32Z3	PR813-224- * -.34-TR-32Z3
8	.75	N/A	3	36	11-1/8	17-13/16	66	PR813-156- * -.75-TR-32Z3	NOT AVAILABLE
PRECISION GUIDED ROD STYLES (PS)									
3	.34	.23	3	23-1/4	6-1/8	10-1/16	25	PS813-156- * -.34-TR-12Z3	PS813-224- * -.23-TR-12Z3
3	.50	.34	3	26-1/4	6-1/8	13-1/16	25	PS813-156- * -.50-TR-12Z3	PS813-224- * -.34-TR-12Z3
6	.34	.23	6	28-7/8	9-3/4	10-1/16	50	PS813-156- * -.34-TR-24Z3	PS813-224- * -.23-TR-24Z3
6	.50	.34	6	31-7/8	9-3/4	13-1/16	50	PS813-156- * -.50-TR-24Z3	PS813-224- * -.34-TR-24Z3
6	.75	N/A	6	36-5/8	9-3/4	17-13/16	50	PS813-156- * -.75-TR-24Z3	NOT AVAILABLE
8	.34	.23	6	32-7/8	13-3/4	10-1/16	66	PS813-156- * -.34-TR-32Z3	PS813-224- * -.23-TR-32Z3
8	.50	.34	6	35-7/8	13-3/4	13-1/16	66	PS813-156- * -.50-TR-32Z3	PS813-224- * -.34-TR-32Z3
8	.75	N/A	6	40-5/8	13-3/4	17-13/16	66	PS813-156- * -.75-TR-32Z3	NOT AVAILABLE

* Replace with "CFF" for Front Flange mounting or "FBL" for Front Block mounting.

FEATURES:	156:1	224:1
Maximum Advance Force-using 100 psi (lbs)	830	830
Maximum Return Force-using 100 psi (lbs)	590	590
Force Output Range using 20-100 psi (lbs)	3120-15600	4480-22400
EE1 Return Port-air (NPT)	3/8	3/8
EE2 Advance Port-fluid (NPT)	3/4	3/4
EE3 Intensifier Port-air (NPT)	3/8	3/8

MODEL NUMBER BREAKDOWN

PR 8 13 - 156 - CFF - .50 - TR -32Z3

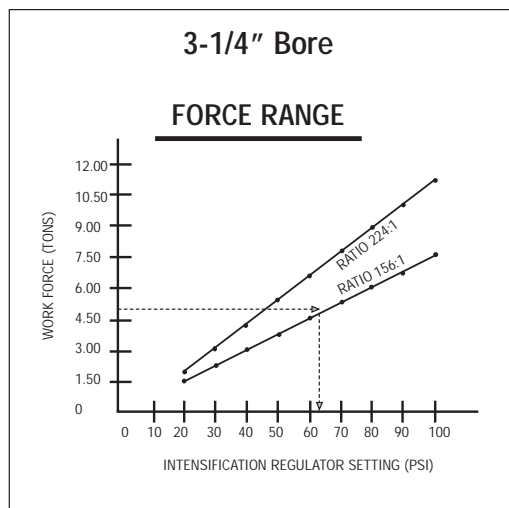
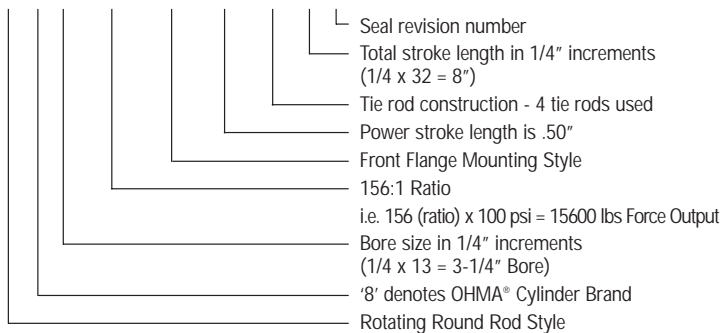

Example: 5.0 tons work force requires a 64 psi regulator setting with a 156:1 ratio cylinder.

Note: Seal friction and standard manufacturing tolerances may reduce the effective OHMA® cylinder ratio by approximately 5-10%. Contact CenterLine for additional information.

Rod end style, port location, total stroke, ratio and power stroke modifications are available upon request. For details, consult CenterLine® Automation Components Division.

The OHMA® Cylinder is a patented product. CenterLine (Windsor) Limited reserves the right to change specifications.

PIERCING CYLINDERS

4" Bore, 262:1 and 300:1 Ratio - Technical Specifications

BARREL ASSEMBLY

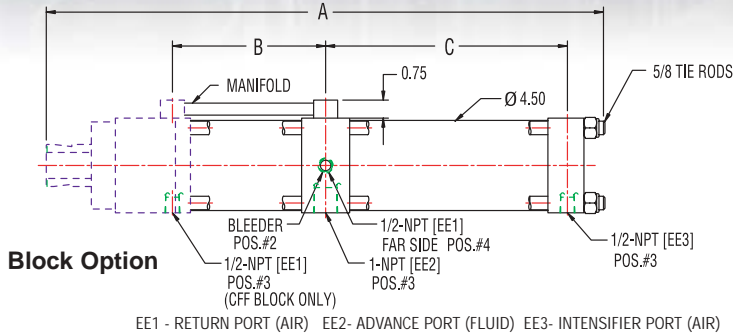

PORT POSITION DESIGNATION

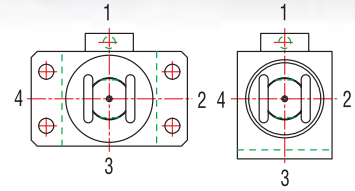

CFF Block

FBL Block

Front View

FRONT FLANGE MOUNTING STYLE (CFF)

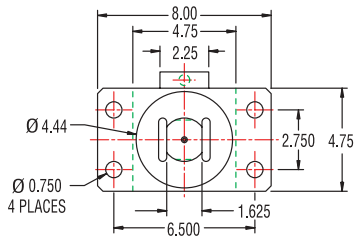

Front View

3" Construction

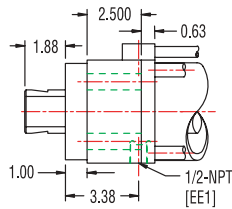

6" Construction

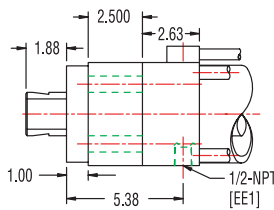

Typical Mounting Configuration

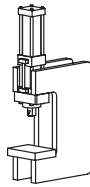

ROD END STYLE DESIGNATION

Rotating Round Rod (PR)

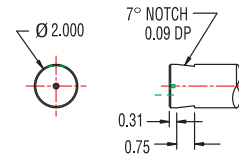

Precision Guided Rod (PS)

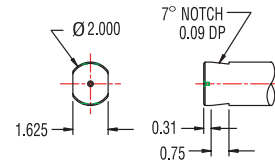

FRONT BLOCK MOUNTING STYLE (FBL)

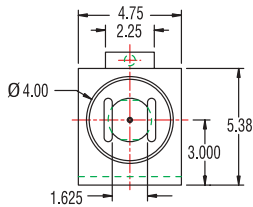

Front View

3" Construction

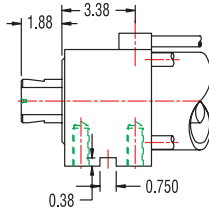

6" Construction

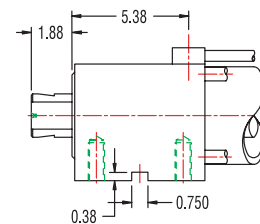

Typical Mounting Configuration

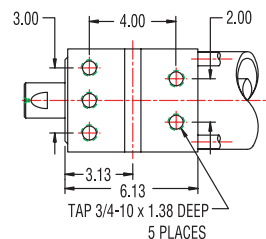
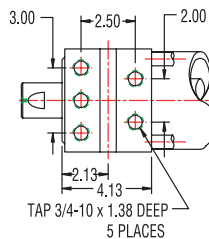
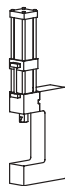

Rod end style, port location, total stroke, ratio and power stroke modifications are available upon request. For details, consult CenterLine® Automation Components Division. The OHMA® Cylinder is a patented product. CenterLine (Windsor) Limited reserves the right to change specifications.

PIERCING CYLINDERS

4" Bore, 262:1 and 300:1 Ratio - Dimensional Specifications

Total Stroke (in.)	Power Stroke (in.)		Block Type (in.)	"A" (in.)	"B" (in.)	"C" (in.)	Fluid Req'd (cu. in.)	Model Number	
	262:1	300:1						262:1 Ratio	300:1 Ratio
ROTATING ROUND ROD STYLES (PR)									
3	.34	.29	3	25-1/8	6-15/16	11-1/4	38	PR816-262- * -.34-TR-12Z3	PR816-300- * -.29-TR-12Z3
3	.50	.43	3	28-1/2	6-15/16	14-5/8	38	PR816-262- * -.50-TR-12Z3	PR816-300- * -.43-TR-12Z3
6	.34	.29	6	30-3/4	10-9/16	11-1/4	75	PR816-262- * -.34-TR-24Z3	PR816-300- * -.29-TR-24Z3
6	.50	.43	6	34-1/8	10-9/16	14-5/8	75	PR816-262- * -.50-TR-24Z3	PR816-300- * -.43-TR-24Z3
6 [†]	.75	.64	6	39-1/4	10-9/16	19-3/4	75	PR816-262- * -.75-TR-24Z3	PR816-300- * -.64-TR-24Z3
8	.34	.29	3	30-1/8	11-15/16	11-1/4	101	PR816-262- * -.34-TR-32Z3	PR816-300- * -.29-TR-32Z3
8	.50	.43	3	33-1/2	11-15/16	14-5/8	101	PR816-262- * -.50-TR-32Z3	PR816-300- * -.43-TR-32Z3
8 [†]	.75	.64	3	38-5/8	11-15/16	19-3/4	101	PR816-262- * -.75-TR-32Z3	PR816-300- * -.64-TR-32Z3
PRECISION GUIDED ROD STYLES (PS)									
3	.34	.29	3	25-1/8	6-15/16	11-1/4	38	PS816-262- * -.34-TR-12Z3	PS816-300- * -.29-TR-12Z3
3	.50	.43	3	28-1/2	6-15/16	14-5/8	38	PS816-262- * -.50-TR-12Z3	PS816-300- * -.43-TR-12Z3
6	.34	.29	6	30-3/4	10-9/16	11-1/4	75	PS816-262- * -.34-TR-24Z3	PS816-300- * -.29-TR-24Z3
6	.50	.43	6	34-1/8	10-9/16	14-5/8	75	PS816-262- * -.50-TR-24Z3	PS816-300- * -.43-TR-24Z3
6 [†]	.75	.64	6	39-1/4	10-9/16	19-3/4	75	PS816-262- * -.75-TR-24Z3	PS816-300- * -.64-TR-24Z3
8	.34	.29	6	34-3/4	14-9/16	11-1/4	101	PS816-262- * -.34-TR-32Z3	PS816-300- * -.29-TR-32Z3
8	.50	.43	6	38-1/8	14-9/16	14-5/8	101	PS816-262- * -.50-TR-32Z3	PS816-300- * -.43-TR-32Z3
8	.75	.64	6	43-1/4	14-9/16	19-3/4	101	PS816-262- * -.75-TR-32Z3	PS816-300- * -.64-TR-32Z3
* Replace with "CFF" for Front Flange mounting or "FBL" for Front Block mounting. † The cylinder must have a minimum 1" low pressure advance stroke in order to produce the full .75" power stroke.									

FEATURES:	262:1	300:1
Maximum Advance Force-using 100 psi (lbs)	1250	1250
Maximum Return Force-using 100 psi (lbs)	940	940
Force Output Range using 20-100 psi (lbs)	5240-26200	6000-30000
EE1 Return Port-air (NPT)	1/2	1/2
EE2 Advance Port-fluid (NPT)	1	1
EE3 Intensifier Port-air (NPT)	1/2	1/2

MODEL NUMBER BREAKDOWN

PS 8 16 - 262 - FBL - .75 - TR - 24Z3

- Seal revision number
- Total stroke length in 1/4" increments (1/4 x 24 = 6")
- Tie rod construction - 4 tie rods used
- Power stroke length is .75"
- Front Block Mounting Style
- 262:1 Ratio
i.e. 262 (ratio) x 100 psi = 26200 lbs Force Output
- Bore size in 1/4" increments (1/4 x 16 = 4" Bore)
- '8' denotes OHMA® Cylinder Brand
- Precision Guided Rod Style

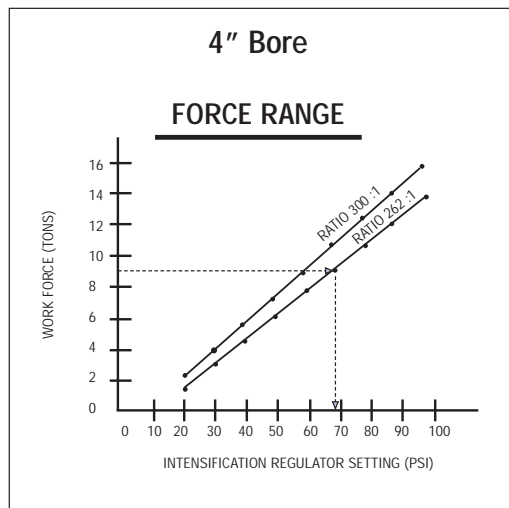

Example: 9.0 tons work force requires a 69 psi regulator setting with a 262:1 ratio cylinder.

Note: Seal friction and standard manufacturing tolerances may reduce the effective OHMA® cylinder ratio by approximately 5-10%. Contact CenterLine for additional information.

Rod end style, port location, total stroke, ratio and power stroke modifications are available upon request. For details, consult CenterLine® Automation Components Division.

The OHMA® Cylinder is a patented product. CenterLine (Windsor) Limited reserves the right to change specifications.

PIERCING CYLINDERS

5" Bore, 387:1 - Technical Specifications

BARREL ASSEMBLY

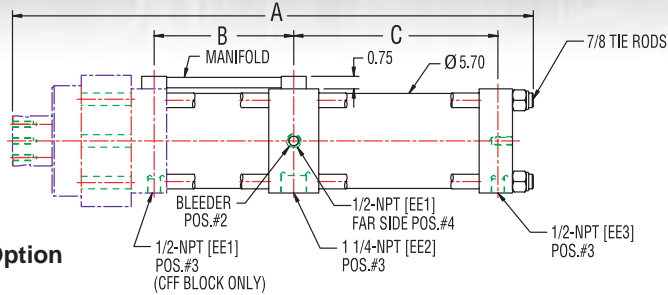

EE1 - RETURN PORT (AIR) EE2- ADVANCE PORT (FLUID) EE3- INTENSIFIER PORT (AIR)

PORT POSITION DESIGNATION

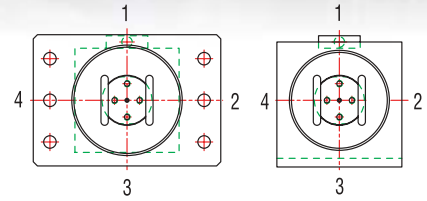

Front View

FRONT FLANGE MOUNTING STYLE (CFF)

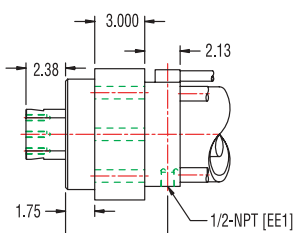
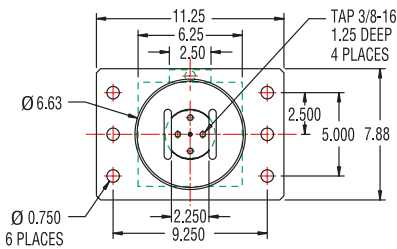

Front View

Side View

Typical Mounting Configuration

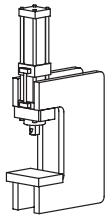

ROD END STYLE DESIGNATION

Rotating Round Rod (PR)

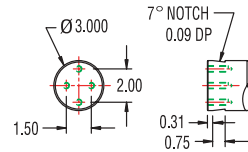

Precision Guided Rod (PS)

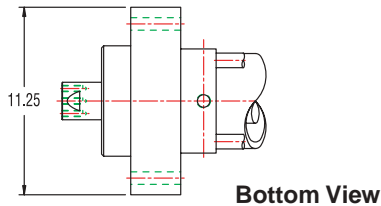
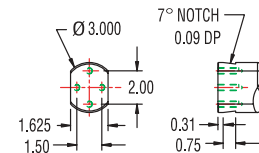

FRONT BLOCK MOUNTING STYLE (FBL)

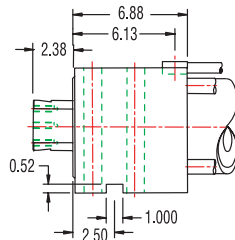
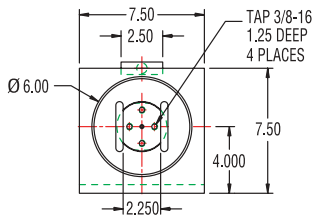

Side View

Typical Mounting Configuration

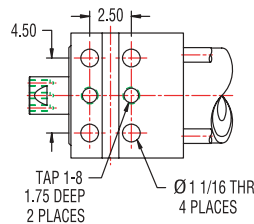
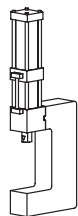

Bottom View

Rod end style, port location, total stroke, ratio and power stroke modifications are available upon request. For details, consult CenterLine® Automation Components Division.

The OHMA® Cylinder is a patented product. CenterLine (Windsor) Limited reserves the right to change specifications.

PIERCING CYLINDERS

5" Bore, 387:1 Ratio - Dimensional Specifications

Total Stroke (in.)	Power Stroke (in.) 387:1	Block Type (in.)	"A" (in.)	"B" (in.)	"C" (in.)	Fluid Req'd (cu. in.)	Model Number 387:1 Ratio
ROTATING ROUND ROD STYLES (PR)							
4	.34	6	31-1/4	8-3/8	12-1/4	79	PR820-387- * -.34-UR-16Z3
4	.50	6	34-3/8	8-3/8	15-3/8	79	PR820-387- * -.50-UR-16Z3
6	.34	6	33-1/4	10-3/8	12-1/4	118	PR820-387- * -.34-UR-24Z3
6	.50	6	36-3/8	10-3/8	15-3/8	118	PR820-387- * -.50-UR-24Z3
6	.75	6	41-1/4	10-3/8	20-1/4	118	PR820-387- * -.75-UR-24Z3
8	.34	6	35-1/4	12-3/8	12-1/4	157	PR820-387- * -.34-UR-32Z3
8	.50	6	38-3/8	12-3/8	15-3/8	157	PR820-387- * -.50-UR-32Z3
8	.75	6	43-1/4	12-3/8	20-1/4	157	PR820-387- * -.75-UR-32Z3
PRECISION GUIDED ROD STYLES (PS)							
4	.34	6	31-1/4	8-3/8	12-1/4	79	PS820-387- * -.34-UR-16Z3
4	.50	6	34-3/8	8-3/8	15-3/8	79	PS820-387- * -.50-UR-16Z3
6	.34	6	33-1/4	10-3/8	12-1/4	118	PS820-387- * -.34-UR-24Z3
6	.50	6	36-3/8	10-3/8	15-3/8	118	PS820-387- * -.50-UR-24Z3
6	.75	6	41-1/4	10-3/8	20-1/4	118	PS820-387- * -.75-UR-24Z3
8	.34	6	37-1/4	14-3/8	12-1/4	157	PS820-387- * -.34-UR-32Z3
8	.50	6	40-3/8	14-3/8	15-3/8	157	PS820-387- * -.50-UR-32Z3
8	.75	6	45-1/4	14-3/8	20-1/4	157	PS820-387- * -.75-UR-32Z3
* Replace with "CFF" for Front Flange mounting or "FBL" for Front Block mounting.							

FEATURES:

Maximum Advance Force-using 100 psi (lbs)	1960
Maximum Return Force-using 100 psi (lbs)	1255
Force Output Range using 20-100 psi (lbs)	7740-38700
EE1 Return Port-air (NPT)	1/2
EE2 Advance Port-fluid (NPT)	1-1/4
EE3 Intensifier Port-air (NPT)	1/2

387:1

MODEL NUMBER BREAKDOWN

PS 8 20 - 387 - FBL - .75 - UR* - 24Z3

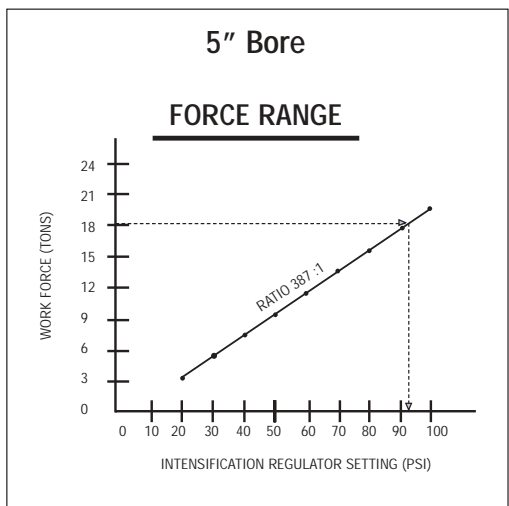
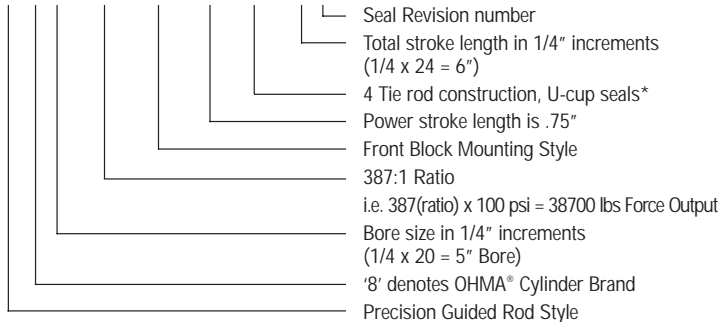

Example: 18.0 tons work force requires a 93 psi regulator setting.

Note: Seal friction and standard manufacturing tolerances may reduce the effective OHMA® cylinder ratio by approximately 5-10%. Contact CenterLine for additional information.

* U-cup seals are incorporated in all 5, 6 and 8" bore cylinders.
The UR and UR8 cylinders are fully retrofittable to previous TR and TR8 styles.

Rod end style, port location, total stroke, ratio and power stroke modifications are available upon request. For details, consult CenterLine® Automation Components Division.

The OHMA® Cylinder is a patented product. CenterLine (Windsor) Limited reserves the right to change specifications.

PIERCING CYLINDERS

6" Bore, 538:1 - Technical Specifications

BARREL ASSEMBLY

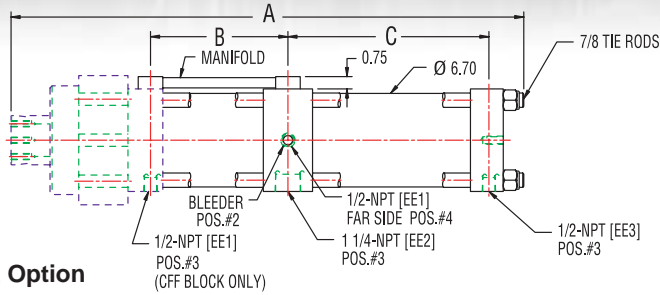

Block Option

EE1 - RETURN PORT (AIR) EE2- ADVANCE PORT (FLUID) EE3- INTENSIFIER PORT (AIR)

PORT POSITION DESIGNATION

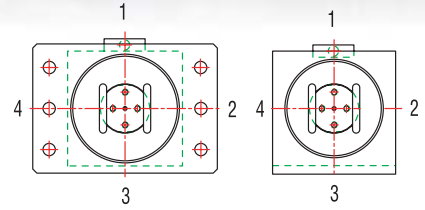

CFF Block

FBL Block

Front View

FRONT FLANGE MOUNTING STYLE (CFF)

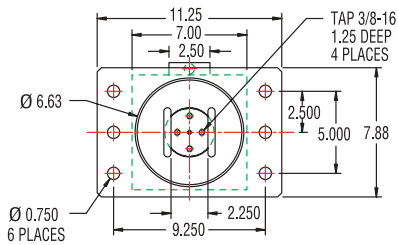

Front View

Typical Mounting Configuration

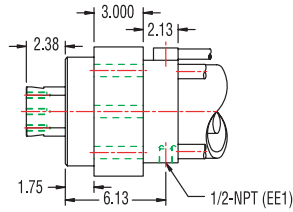
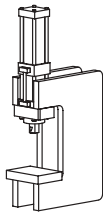

Side View

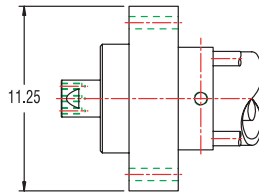

Bottom View

ROD END STYLE DESIGNATION

Rotating Round Rod (PR)

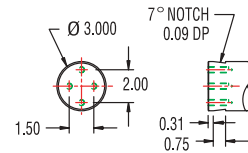

Precision Guided Rod (PS)

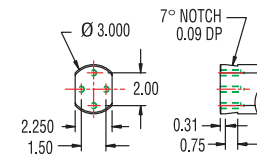

FRONT BLOCK MOUNTING STYLE (FBL)

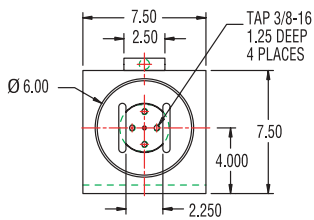

Front View

Typical Mounting Configuration

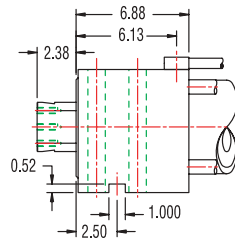
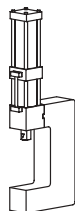

Side View

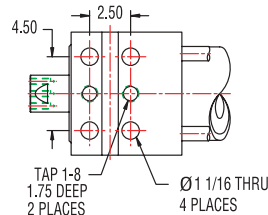

Bottom View

Rod end style, port location, total stroke, ratio and power stroke modifications are available upon request. For details, consult CenterLine® Automation Components Division.

The OHMA® Cylinder is a patented product. CenterLine (Windsor) Limited reserves the right to change specifications.

PIERCING CYLINDERS

6" Bore, 538:1 Ratio - Dimensional Specifications

Total Stroke (in.)	Power Stroke (in.) 538:1	Block Type (in.)	"A" (in.)	"B" (in.)	"C" (in.)	Fluid Req'd (cu. in.)	Model Number 538:1 Ratio
ROTATING ROUND ROD STYLES (PR)							
4	.34	6	31	8-3/8	12	113	PR824-538- * -.34-UR-16Z3
4	.50	6	34	8-3/8	15	113	PR824-538- * -.50-UR-16Z3
6	.34	6	33	10-3/8	12	170	PR824-538- * -.34-UR-24Z3
6	.50	6	36	10-3/8	15	170	PR824-538- * -.50-UR-24Z3
6	.75	6	40-3/4	10-3/8	19-3/4	170	PR824-538- * -.75-UR-24Z3
8	.34	6	35	12-3/8	12	226	PR824-538- * -.34-UR-32Z3
8	.50	6	38	12-3/8	15	226	PR824-538- * -.50-UR-32Z3
8	.75	6	42-3/4	12-3/8	19-3/4	226	PR824-538- * -.75-UR-32Z3
PRECISION GUIDED ROD STYLES (PS)							
4	.34	6	31	8-3/8	12	113	PS824-538- * -.34-UR-16Z3
4	.50	6	34	8-3/8	15	113	PS824-538- * -.50-UR-16Z3
6	.34	6	33	10-3/8	12	170	PS824-538- * -.34-UR-24Z3
6	.50	6	36	10-3/8	15	170	PS824-538- * -.50-UR-24Z3
6	.75	6	40-3/4	10-3/8	19-3/4	170	PS824-538- * -.75-UR-24Z3
8	.34	6	37	14-3/8	12	226	PS824-538- * -.34-UR-32Z3
8	.50	6	40	14-3/8	15	226	PS824-538- * -.50-UR-32Z3
8	.75	6	44-3/4	14-3/8	19-3/4	226	PS824-538- * -.75-UR-32Z3
* Replace with "CFF" for Front Flange mounting or "FBL" for Front Block mounting.							

FEATURES:

Maximum Advance Force-using 100 psi (lbs)	538:1	2825
Maximum Return Force-using 100 psi (lbs)		2120
Force Output Range using 20-100 psi (lbs)		10760-53800
EE1 Return Port-air (NPT)		1/2
EE2 Advance Port-fluid (NPT)		1-1/4
EE3 Intensifier Port-air (NPT)		1/2

MODEL NUMBER BREAKDOWN

PS 8 24 - 538 - FBL - .50 - UR* -24Z3

Seal revision number	
Total stroke length in 1/4" increments (1/4 x 24 = 6")	
4 Tie rod construction, U-cup seals*	
Power stroke length is .50"	
Front Block Mounting Style	
538:1 Ratio	
i.e. 538(ratio) x 100 psi = 53800 lbs Force Output	
Bore size in 1/4" increments (1/4 x 24 = 6" Bore)	
'8' denotes OHMA® Cylinder Brand	
Precision Guided Rod Style	

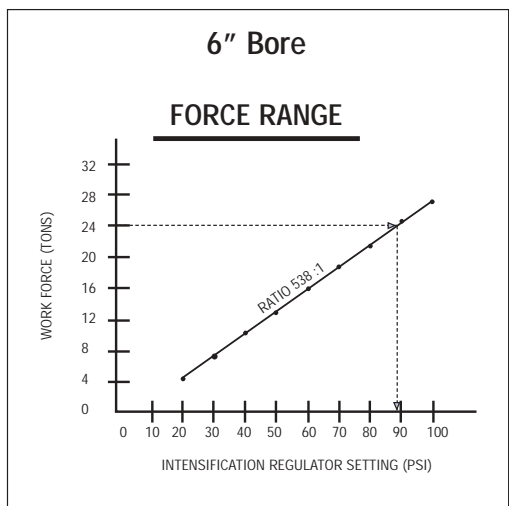

Example: 24.0 tons work force requires a 89 psi regulator setting.

Note: Seal friction and standard manufacturing tolerances may reduce the effective OHMA® cylinder ratio by approximately 5-10%. Contact CenterLine for additional information.

* U-cup seals are incorporated in all 5, 6 and 8" bore cylinders.
The UR and UR8 cylinders are fully retrofittable to previous TR and TR8 styles.

Rod end style, port location, total stroke, ratio and power stroke modifications are available upon request. For details, consult CenterLine® Automation Components Division.

The OHMA® Cylinder is a patented product. CenterLine (Windsor) Limited reserves the right to change specifications.

PIERCING CYLINDERS

6" Bore, 800:1 - Technical Specifications

BARREL ASSEMBLY

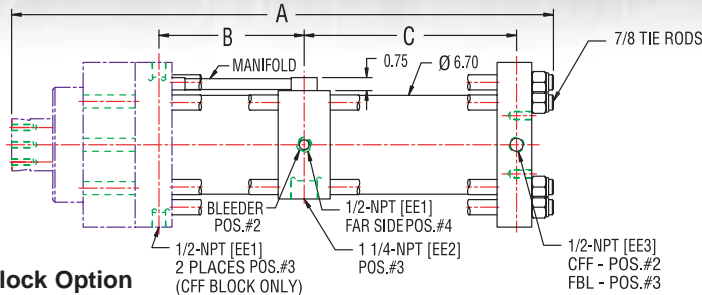

Block Option

EE1 - RETURN PORT (AIR) EE2- ADVANCE PORT (FLUID) EE3- INTENSIFIER PORT (AIR)

PORT POSITION DESIGNATION

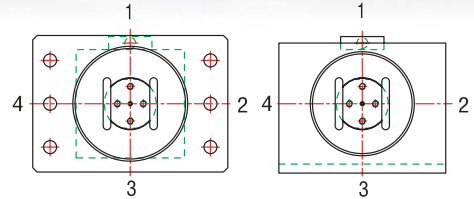

CFF Block

FBL Block

Front View

FRONT FLANGE MOUNTING STYLE (CFF)

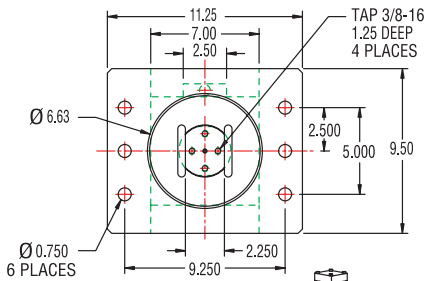

Front View

Typical Mounting Configuration

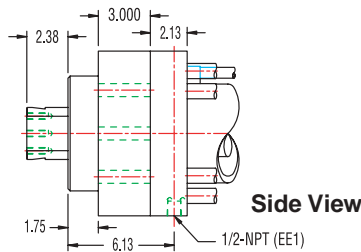
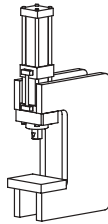

Side View

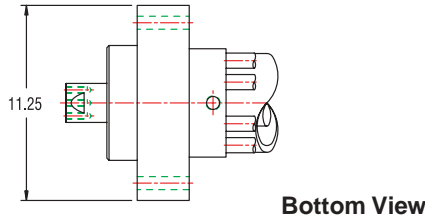

Bottom View

ROD END STYLE DESIGNATION

Rotating Round Rod (PR)

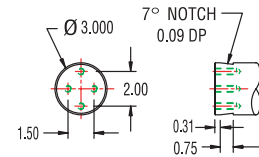

Precision Guided Rod (PS)

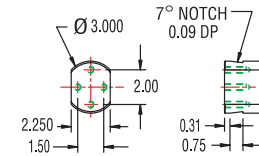

FRONT BLOCK MOUNTING STYLE (FBL)

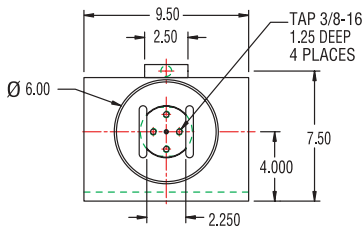

Front View

Typical Mounting Configuration

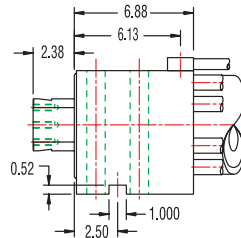
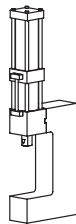

Side View

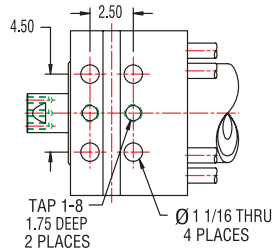

Bottom View

Rod end style, port location, total stroke, ratio and power stroke modifications are available upon request. For details, consult CenterLine® Automation Components Division.

The OHMA® Cylinder is a patented product. CenterLine (Windsor) Limited reserves the right to change specifications.

PIERCING CYLINDERS

6" Bore, 800:1 Ratio - Dimensional Specifications

Total Stroke (in.)	Power Stroke (in.) 800:1	Block Type (in.)	"A" (in.)	"B" (in.)	"C" (in.)	Fluid Req'd (cu. in.)	Model Number 800:1 Ratio
ROTATING ROUND ROD STYLES (PR)							
4	.22	6	31	8-3/8	12	113	PR824-800- * -.22-UR8-16Z3
4	.34	6	34	8-3/8	15	113	PR824-800- * -.34-UR8-16Z3
6	.22	6	33	10-3/8	12	170	PR824-800- * -.22-UR8-24Z3
6	.34	6	36	10-3/8	15	170	PR824-800- * -.34-UR8-24Z3
6	.50	6	40-3/4	10-3/8	19-3/4	170	PR824-800- * -.50-UR8-24Z3
8	.22	6	35	12-3/8	12	226	PR824-800- * -.22-UR8-32Z3
8	.34	6	38	12-3/8	15	226	PR824-800- * -.34-UR8-32Z3
8	.50	6	42-3/4	12-3/8	19-3/4	226	PR824-800- * -.50-UR8-32Z3
PRECISION GUIDED ROD STYLES (PS)							
4	.22	6	31	8-3/8	12	113	PS824-800- * -.22-UR8-16Z3
4	.34	6	34	8-3/8	15	113	PS824-800- * -.34-UR8-16Z3
6	.22	6	33	10-3/8	12	170	PS824-800- * -.22-UR8-24Z3
6	.34	6	36	10-3/8	15	170	PS824-800- * -.34-UR8-24Z3
6	.50	6	40-3/4	10-3/8	19-3/4	170	PS824-800- * -.50-UR8-24Z3
8	.22	6	37	14-3/8	12	226	PS824-800- * -.22-UR8-32Z3
8	.34	6	40	14-3/8	15	226	PS824-800- * -.34-UR8-32Z3
8	.50	6	44-3/4	14-3/8	19-3/4	226	PS824-800- * -.50-UR8-32Z3

* Replace with "CFF" for Front Flange mounting or "FBL" for Front Block mounting.

FEATURES:	800:1
Maximum Advance Force-using 100 psi (lbs)	2825
Maximum Return Force-using 100 psi (lbs)	2120
Force Output Range using 20-100 psi (lbs)	16000-80000
EE1 Return Port-air (NPT)	1/2
EE2 Advance Port-fluid (NPT)	1-1/4
EE3 Intensifier Port-air (NPT)	1/2

MODEL NUMBER BREAKDOWN

PS 8 24 - 800 - FBL - .22 - UR8* - 24Z3

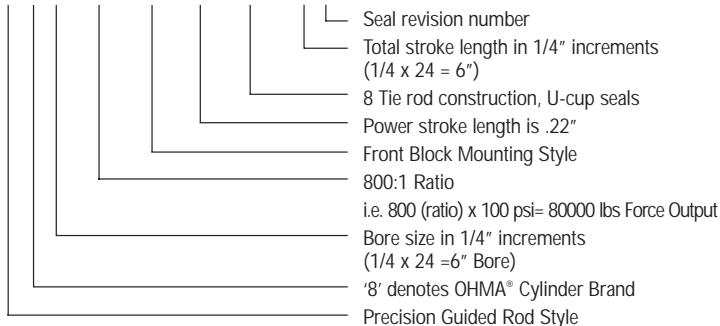

6" Bore 8 Tie Rods

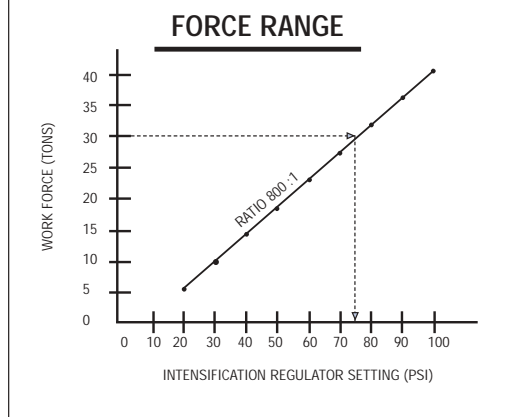

Example: 30.0 tons work force requires a 75 psi regulator setting.

Note: Seal friction and standard manufacturing tolerances may reduce the effective OHMA® cylinder ratio by approximately 5-10%. Contact CenterLine for additional information.

* U-cup seals are incorporated in all 5, 6 and 8" bore cylinders.
The UR and UR8 cylinders are fully retrofittable to previous TR and TR8 styles.

Rod end style, port location, total stroke, ratio and power stroke modifications are available upon request. For details, consult CenterLine® Automation Components Division.

The OHMA® Cylinder is a patented product. CenterLine (Windsor) Limited reserves the right to change specifications.

PIERCING CYLINDERS

8" Bore, 1430:1 and 1700:1 - Technical Specifications

BARREL ASSEMBLY

PORT POSITION DESIGNATION

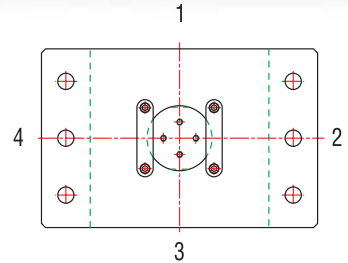
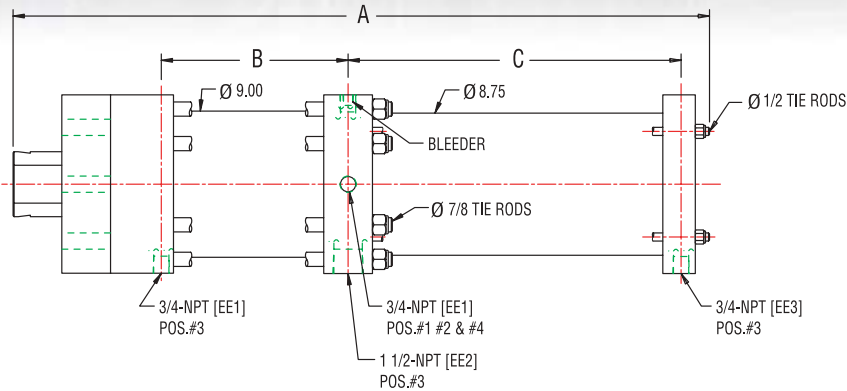

CFF Block
Front View

EE1 - RETURN PORT (AIR) EE2- ADVANCE PORT (FLUID) EE3- INTENSIFIER PORT (AIR)

FRONT FLANGE MOUNTING STYLE (CFF)

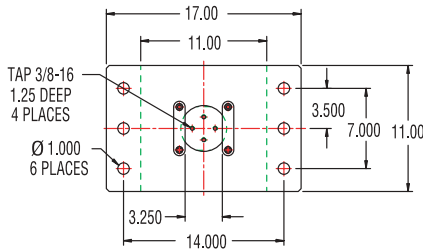

Front View

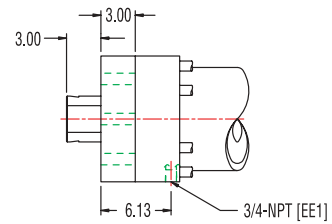

Side View

Typical Mounting Configuration

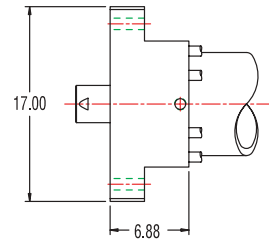
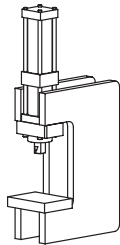

Bottom View

ROD END STYLE DESIGNATION

Rotating Round Rod (PR)

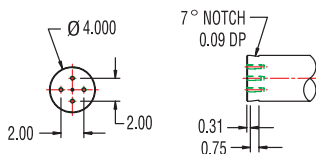

Precision Guided Rod (PS)

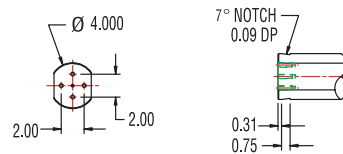

Rod end style, port location, total stroke, ratio and power stroke modifications are available upon request. For details, consult CenterLine® Automation Components Division.

The OHMA® Cylinder is a patented product. CenterLine (Windsor) Limited reserves the right to change specifications.

PIERCING CYLINDERS

8" Bore, 1430:1 and 1700:1 Ratio - Dimensional Specifications

Total Stroke (in.)	Power Stroke (in.)		"A" (in.)	"B" (in.)	"C" (in.)	Fluid Req'd (cu. in.)	Model Number	
	1430:1	1700:1					1430:1 Ratio	1700:1 Ratio
ROTATING ROUND ROD STYLES (PR)								
4	.34	.28	36-5/16	9-1/2	15-15/16	201	PR832-1430-CFF-.34-UR8-16Z3	PR832-1700-CFF-.28-UR8-16Z3
4 [†]	.50	.42	40-7/8	9-1/2	20-1/2	201	PR832-1430-CFF-.50-UR8-16Z3	PR832-1700-CFF-.42-UR8-16Z3
6	.34	.28	38-5/16	11-1/2	15-15/16	302	PR832-1430-CFF-.34-UR8-24Z3	PR832-1700-CFF-.28-UR8-24Z3
6	.50	.42	42-7/8	11-1/2	20-1/2	302	PR832-1430-CFF-.50-UR8-24Z3	PR832-1700-CFF-.42-UR8-24Z3
8	.34	.28	40-5/16	13-1/2	15-15/16	402	PR832-1430-CFF-.34-UR8-32Z3	PR832-1700-CFF-.28-UR8-32Z3
8	.50	.42	44-7/8	13-1/2	20-1/2	402	PR832-1430-CFF-.50-UR8-32Z3	PR832-1700-CFF-.42-UR8-32Z3
8	.60	.50	47-11/16	13-1/2	23-5/16	402	PR832-1430-CFF-.60-UR8-32Z3	PR832-1700-CFF-.50-UR8-32Z3
PRECISION GUIDED ROD STYLES (PS)								
4	.34	.28	36-5/16	9-1/2	15-15/16	201	PS832-1430-CFF-.34-UR8-16Z3	PS832-1700-CFF-.28-UR8-16Z3
4 [†]	.50	.42	40-7/8	9-1/2	20-1/2	201	PS832-1430-CFF-.50-UR8-16Z3	PS832-1700-CFF-.42-UR8-16Z3
6	.34	.28	38-5/16	11-1/2	15-15/16	302	PS832-1430-CFF-.34-UR8-24Z3	PS832-1700-CFF-.28-UR8-24Z3
6	.50	.42	42-7/8	11-1/2	20-1/2	302	PS832-1430-CFF-.50-UR8-24Z3	PS832-1700-CFF-.42-UR8-24Z3
8	.34	.28	42-5/16	15-1/2	15-15/16	402	PS832-1430-CFF-.34-UR8-32Z3	PS832-1700-CFF-.28-UR8-32Z3
8	.50	.42	46-7/8	15-1/2	20-1/2	402	PS832-1430-CFF-.50-UR8-32Z3	PS832-1700-CFF-.42-UR8-32Z3
8	.60	.50	49-11/16	15-1/2	23-5/16	402	PS832-1430-CFF-.60-UR8-32Z3	PS832-1700-CFF-.50-UR8-32Z3
† The cylinder must have a minimum 1" low pressure advance stroke in order to produce the full .50" power stroke.								

FEATURES:	1430:1	1700:1
Maximum Advance Force-using 100 psi (lbs)	5025	5025
Maximum Return Force-using 100 psi (lbs)	3765	3765
Force Output Range using 20-100 psi (lbs)	28600-143000	34000-170000
EE1 Return Port-air (NPT)	3/4	3/4
EE2 Advance Port-fluid (NPT)	1-1/2	1-1/2
EE3 Intensifier Port-air (NPT)	3/4	3/4

MODEL NUMBER BREAKDOWN

PS 8 32 - 1700 -CFF - .50 - UR8* - 24Z3

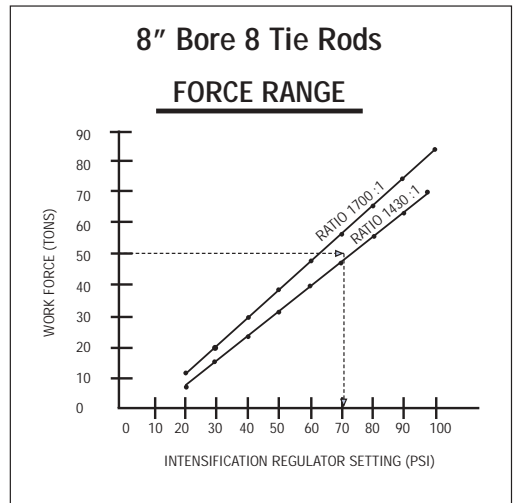
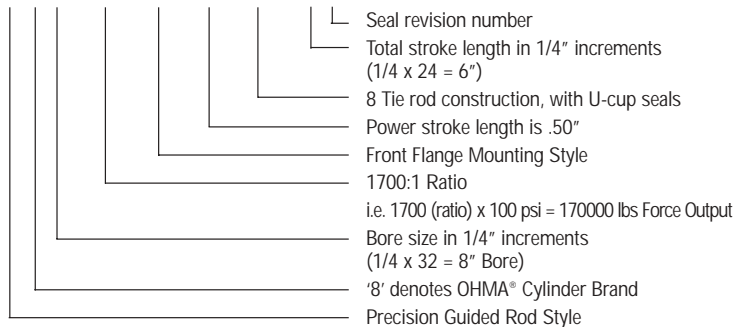

Example: 50 tons work force requires a 70 psi regulator setting with a 1430:1 ratio cylinder.

Note: Seal friction and standard manufacturing tolerances may reduce the effective OHMA® cylinder ratio by approximately 5-10%. Contact CenterLine for additional information.

* U-cup seals are incorporated in all 5, 6 and 8" bore cylinders. The UR and UR8 cylinders are fully retrofittable to previous TR and TR8 styles.

Rod end style, port location, total stroke, ratio and power stroke modifications are available upon request. For details, consult CenterLine® Automation Components Division.

The OHMA® Cylinder is a patented product. CenterLine (Windsor) Limited reserves the right to change specifications.

FLUID RESERVOIRS

ISO & ASB Style

CenterLine (Windsor) Limited manufactures two reservoir styles complete with a machined valve base. The ISO style is manufactured to be compatible with the International Standards Organization stipulations (#5599/1). The ASB (Automotive Sub Base) style is compatible with the current SAE standards (#J2051).

GENERAL GUIDELINES

Consult with CenterLine when selecting reservoirs other than the ISO, ASB or Standard Fluid Reservoirs.

Always use a Fluid Reservoir having larger bore size than the cylinder bore. This will safeguard against agitating the fluid and ensure that it will not become contaminated with air bubbles. The presence of air in the fluid results in reducing the cylinder's rated force output. The fitting and hose (tubing) size is dependent upon the reservoir port sizes.

FLUID RESERVOIR SELECTION

- Step 1** • Once a suitable OHMA® cylinder is selected, determine its fluid requirement needs. The "Dimensional Specifications" chart for each standard OHMA® cylinder lists this information.
- Step 2** • Compare the cylinder's fluid requirement with the **Usable Capacity** ratings of the available reservoirs. When operating more than one cylinder from one Fluid Reservoir, the sum of each cylinder's fluid requirement must be used in choosing a suitable Fluid Reservoir. Contact CenterLine for information concerning the operation of multiple cylinders from one fluid reservoir.
- Step 3** • Specify either **ISO or ASB style reservoir**. Please note that OHMA® does maintain a stock of 120 VAC valves suitable for the ISO style reservoirs. Information concerning appropriate brands of valves for both styles of reservoirs is available from CenterLine.

RECOMMENDED FLUIDS

OHMA® cylinders utilize a combination of BUNA "N" (Nitrile) and polyurethane seals. Light weight fluids that are compatible with these materials are recommended.

TYPICAL FLUID CHARACTERISTICS

- low viscosity to maximize speed (not more than ISO 22 @ 40° C)
- normal (10-50°C) operating temperature
- no phosphate ester components
- maximum pressure developed by cylinder in reference to fluid is 3500 PSI

These standards must be followed to optimize cylinder operation. The following fluids are recommended for use with the OHMA® cylinder.

Eppert	Eppco Spindle Oil (ISO22)	Imperial Oil	Nuto A22
Mobil	Velocite #10, DTE 22	Petro Canada	Harmony AW22
Shell	Tellus 22	Sunoco	Sunvis 922
Texaco	Spindura 22	Exxon	Spinesstic 22

Synthetic Fluids:

Quaker	Quintolubric 220
Shell	Cosmolubric 130HF

NOTE: For brands not listed above, contact the manufacturer for a fluid that will meet the typical fluid characteristics.

RESERVOIR PORT SIZING

RESERVOIR PORT SIZING CHART					NOTES
BORE (in.)	SIDE PORTS	EXHAUST PORTS	FLUID PORT	MTG. HOLE SIZE	
4	3/8 NPT	3/8 NPT	1 NPT	5/16-18	When selecting the ISO style reservoir, the valve characteristics should be 4 way, single solenoid, externally piloted, incorporating ISO 5599/1 interface. When selecting the ASB reservoir, valve to be 4 way air, single solenoid, externally piloted, 2 position, conforming to the SAE standards (#J2051). Both reservoir styles require 2 valves. Contact CenterLine for suitable model numbers.
6	1/2 NPT	3/4 NPT	1-1/4 NPT	5/16-18	
8	1/2 NPT	3/4 NPT	1-1/2 NPT	3/8-16	
10	3/4 NPT	3/4 NPT	1-1/2 NPT	3/8-16	
12	3/4 NPT	3/4 NPT	1-1/2 NPT	3/8-16	

The OHMA® Cylinder is a patented product. CenterLine (Windsor) Limited reserves the right to change specifications.

FLUID RESERVOIRS

ISO Style

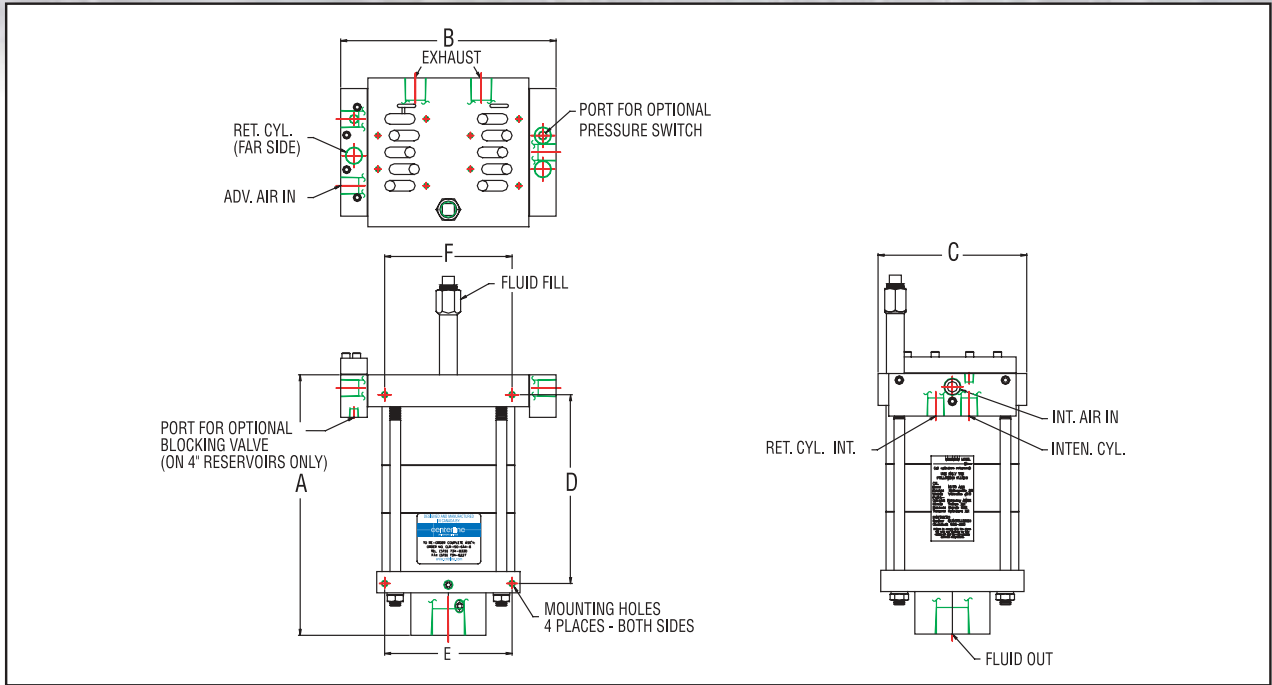

ISO RESERVOIR DIMENSIONAL SPECIFICATIONS

MODEL #	A (in.)	B (in.)	C (in.)	D (in.)	E (in.)	F (in.)	FLUID CAPACITY (cu. in.)	* USABLE CAPACITY (cu. in.)
4" Bore								
CLR-ISO-4A2-7	11	7-3/4	4-3/4	7-15/16	2-3/4	4-5/8	55	25
CLR-ISO-4A2-10	14	7-3/4	4-3/4	10-15/16	2-3/4	4-5/8	95	60
CLR-ISO-4A2-12	16	7-3/4	4-3/4	12-15/16	2-3/4	4-5/8	120	85
6" Bore								
CLR-ISO-6A4-8	12-1/4	10-1/16	7	8-7/8	6	6	155	60
CLR-ISO-6A4-10	14-1/4	10-1/16	7	10-7/8	6	6	210	115
CLR-ISO-6A4-12	16-1/4	10-1/16	7	12-7/8	6	6	270	170
8" Bore								
CLR-ISO-8A4-8	13-3/4	11-9/16	9	9-1/8	8	8	275	100
CLR-ISO-8A4-10	15-3/4	11-9/16	9	11-1/8	8	8	375	200
CLR-ISO-8A4-12	17-3/4	11-9/16	9	13-1/8	8	8	475	300
10" Bore								
CLR-ISO-10A4-8	13-7/8	14	11	9-5/16	8	8	400	195
CLR-ISO-10A4-10	15-7/8	14	11	11-5/16	8	8	560	355
CLR-ISO-10A4-12	17-7/8	14	11	13-5/16	8	8	715	510
CLR-ISO-10A4-16	21-7/8	14	11	17-5/16	8	8	1030	825
12" Bore								
CLR-ISO-12A4-8	14-3/4	16	13	9-3/4	11-3/4	11-3/4	580	280
CLR-ISO-12A4-10	16-3/4	16	13	11-3/4	11-3/4	11-3/4	805	510
CLR-ISO-12A4-12	18-3/4	16	13	13-3/4	11-3/4	11-3/4	1030	735
CLR-ISO-12A4-16	22-3/4	16	13	17-3/4	11-3/4	11-3/4	1485	1190

* NOTE: Usable Capacity represents the maximum volume of fluid that can be used to operate an OHMA® cylinder without risk of aeration. For greater "Usable Capacity" needs, larger fluid reservoirs are available. Contact CenterLine for specifications.

The OHMA® Cylinder is a patented product. CenterLine (Windsor) Limited reserves the right to change specifications.

FLUID RESERVOIRS

ASB Style

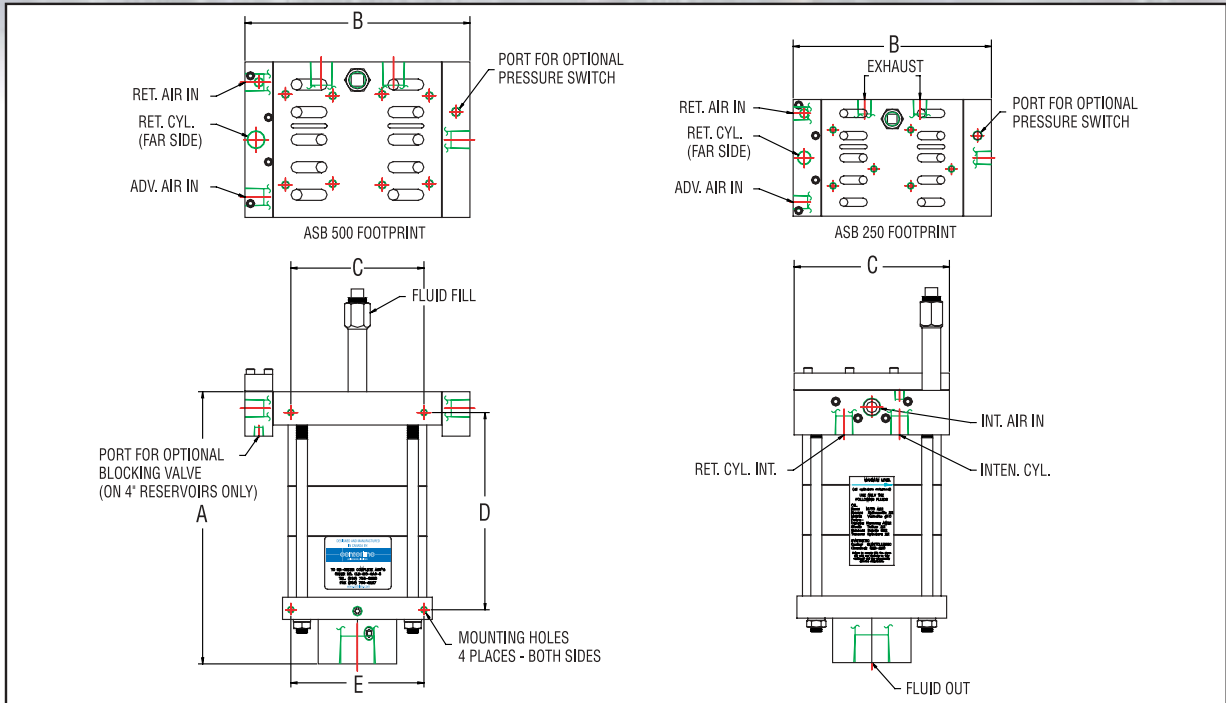

ASB RESERVOIR DIMENSIONAL SPECIFICATIONS

MODEL #	A (in.)	B (in.)	C (in.)	D (in.)	E (in.)	F (in.)	FLUID CAPACITY (cu. in.)	* USABLE CAPACITY (cu. in.)
4" Bore								
CLR-ASB-4A250-7	11	8-7/8	5-1/4	7-3/4	2-3/4	4-5/8	55	25
CLR-ASB-4A250-10	14	8-7/8	5-1/4	10-3/4	2-3/4	4-5/8	95	60
CLR-ASB-4A250-12	16	8-7/8	5-1/4	12-3/4	2-3/4	4-5/8	120	85
6" Bore								
CLR-ASB-6A500-8	12-1/4	10-1/16	7	8-7/8	6	6	155	60
CLR-ASB-6A500-10	14-1/4	10-1/16	7	10-7/8	6	6	210	115
CLR-ASB-6A500-12	16-1/4	10-1/16	7	12-7/8	6	6	270	170
8" Bore								
CLR-ASB-8A500-8	13-3/4	11-9/16	9	9-1/8	8	8	275	100
CLR-ASB-8A500-10	15-3/4	11-9/16	9	11-1/8	8	8	375	200
CLR-ASB-8A500-12	17-3/4	11-9/16	9	13-1/8	8	8	475	300
10" Bore								
CLR-ASB-10A500-8	13-7/8	14	11	9-5/16	8	8	400	195
CLR-ASB-10A500-10	15-7/8	14	11	11-5/16	8	8	560	355
CLR-ASB-10A500-12	17-7/8	14	11	13-5/16	8	8	715	510
CLR-ASB-10A500-16	21-7/8	14	11	17-5/16	8	8	1030	825
12" Bore								
CLR-ASB-12A500-8	14-7/8	16	13	9-3/4	11-3/4	11-3/4	580	280
CLR-ASB-12A500-10	16-7/8	16	13	11-3/4	11-3/4	11-3/4	805	510
CLR-ASB-12A500-12	18-7/8	16	13	13-3/4	11-3/4	11-3/4	1030	735
CLR-ASB-12A500-16	22-7/8	16	13	17-3/4	11-3/4	11-3/4	1485	1190

* NOTE: Usable Capacity represents the maximum volume of fluid that can be used to operate an OHMA® cylinder without risk of aeration. For greater "Usable Capacity" needs, larger fluid reservoirs are available. Contact CenterLine for specifications.

The OHMA® Cylinder is a patented product. CenterLine (Windsor) Limited reserves the right to change specifications.

FLUID RESERVOIRS

Standard Style

The standard fluid reservoirs are designed for use with remote mounted valve packages. These reservoirs are manufactured with aluminum caps and translucent fiberglass barrels. The custom designed baffling system ensures minimal fluid aeration.

Dimensional specifications are shown on page C-6.

CLR-400 Series

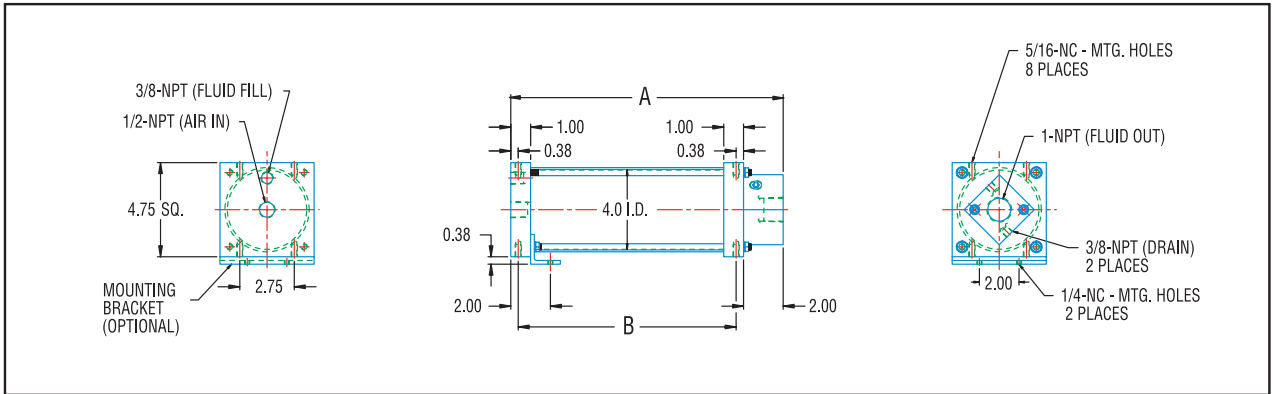

CLR-600 Series

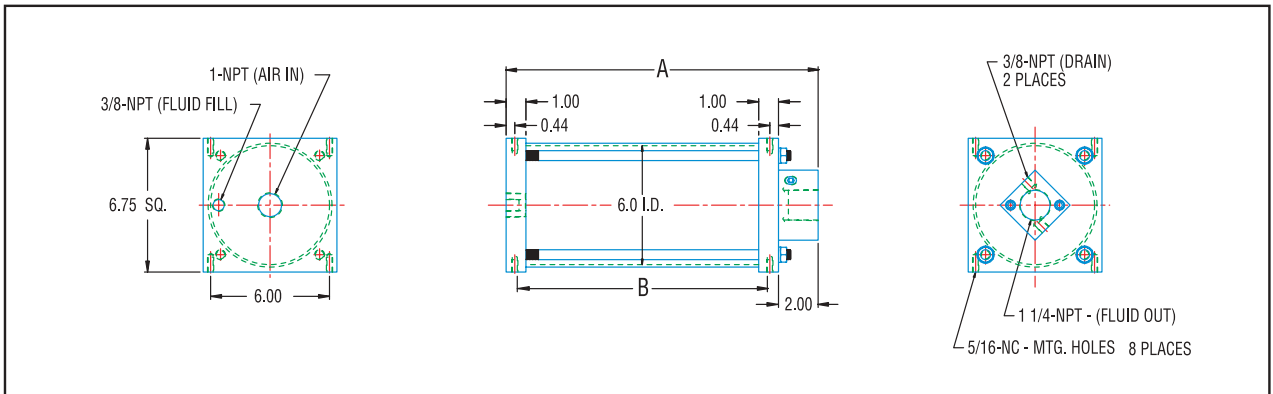

CLR-800 Series

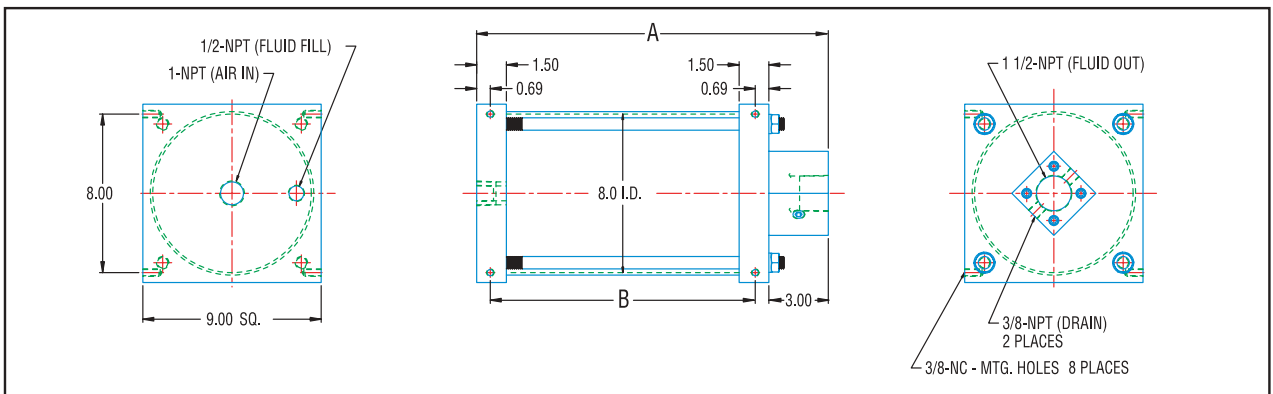

The OHMA® Cylinder is a patented product. CenterLine (Windsor) Limited reserves the right to change specifications.

FLUID RESERVOIRS

Standard Style

CLR-1000 Series

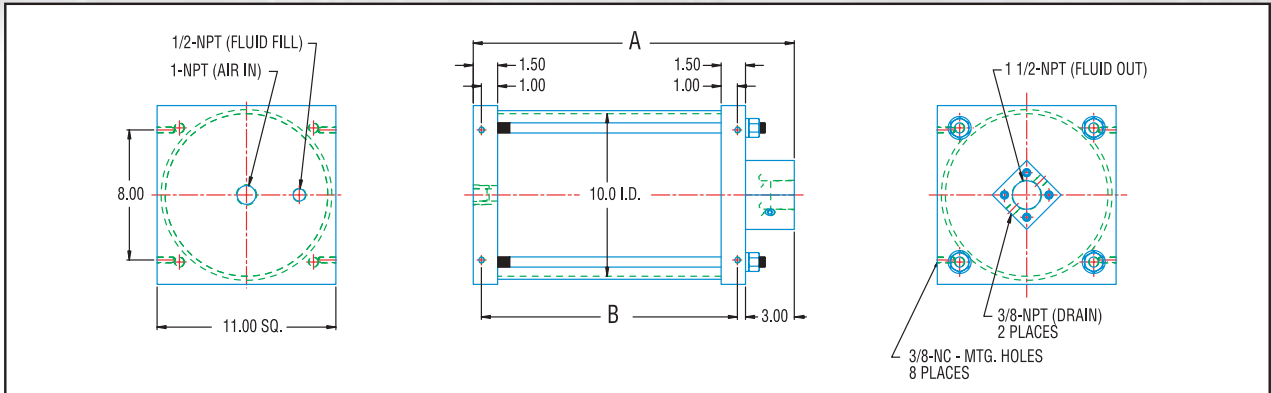

CLR-1200 Series

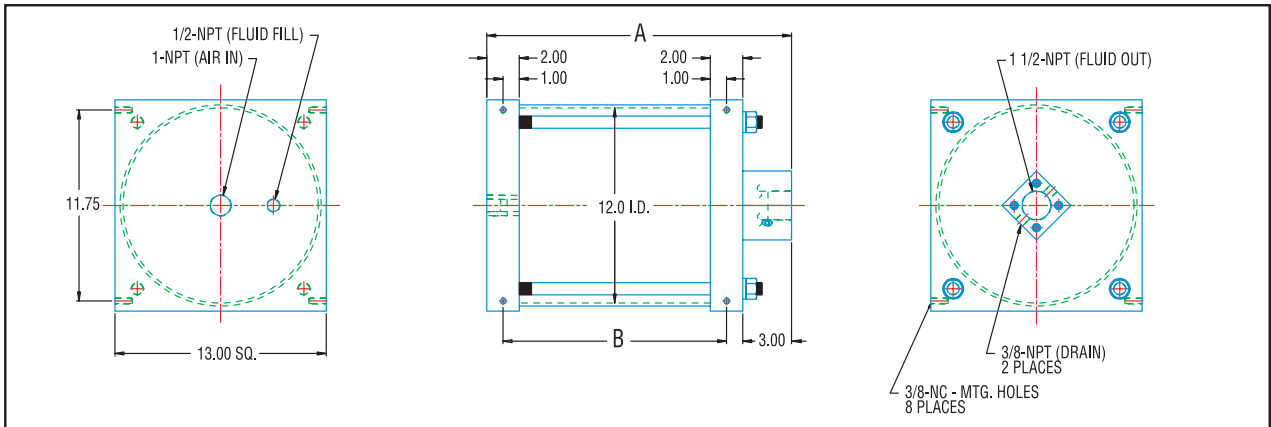

CLR-1400 Series

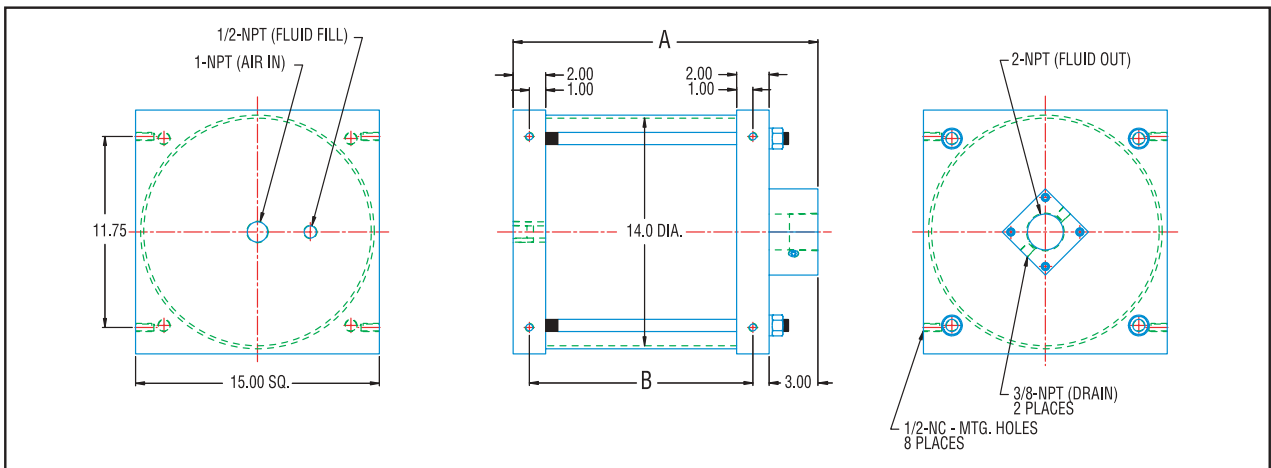

The OHMA® Cylinder is a patented product. CenterLine (Windsor) Limited reserves the right to change specifications.

FLUID RESERVOIRS

Standard Style

STANDARD FLUID RESERVOIR DIMENSIONAL SPECIFICATIONS				
MODEL #	A (Inches)	B (Inches)	TANK CAPACITY (cu. in.)	* USABLE FLUID CAPACITY (cu. in.)
4" BORE				
CLR-400-7	10-3/4	8	55	25
CLR-400-10	13-3/4	11	95	60
CLR-400-12	15-3/4	13	120	85
6" BORE				
CLR-600-8	11-3/4	8-7/8	155	60
CLR-600-10	13-3/4	10-7/8	210	115
CLR-600-12	15-3/4	12-7/8	270	170
8" BORE				
CLR-800-8	13-3/4	9-3/8	275	100
CLR-800-10	15-3/4	11-3/8	375	200
CLR-800-12	17-3/4	13-3/8	475	300
10" BORE				
CLR-1000-8	13-3/4	9-3/4	1400	195
CLR-1000-10	15-3/4	11-3/4	560	355
CLR-1000-12	17-3/4	13-3/4	715	510
12" BORE				
CLR-1200-8	14-3/4	9-3/4	580	280
CLR-1200-10	16-3/4	11-3/4	805	510
CLR-1200-12	18-3/4	13-3/4	1030	735
14" BORE				
CLR-1400-8	14-3/4	9-3/4	790	385
CLR-1400-10	16-3/4	11-3/4	1095	690
CLR-1400-12	18-3/4	13-3/4	1405	1000
<p>* NOTE: Usable Fluid Capacity represents the maximum volume of fluid that can be used to operate an OHMA® cylinder without risk of aeration.</p> <p>For greater "Usable Fluid Capacity" needs, larger fluid reservoirs are available.</p> <p>Contact CenterLine for specifications.</p>				

The OHMA® Cylinder is a patented product. CenterLine (Windsor) Limited reserves the right to change specifications.

PIERCING CYLINDER HOOK-UP

Standard Configuration & "Delicate Touch" Option

Standard Configuration

The basic OHMA® cylinder hook-up is the "Standard Configuration". This hook-up allows for specific control of the intensification air pressure.

"Delicate Touch" Option

The "Delicate Touch" option allows the OHMA® cylinder to be operated with separate advance and intensification air pressure settings. This hook-up configuration is desirable for situations requiring added control over initial advance stroke impact force.

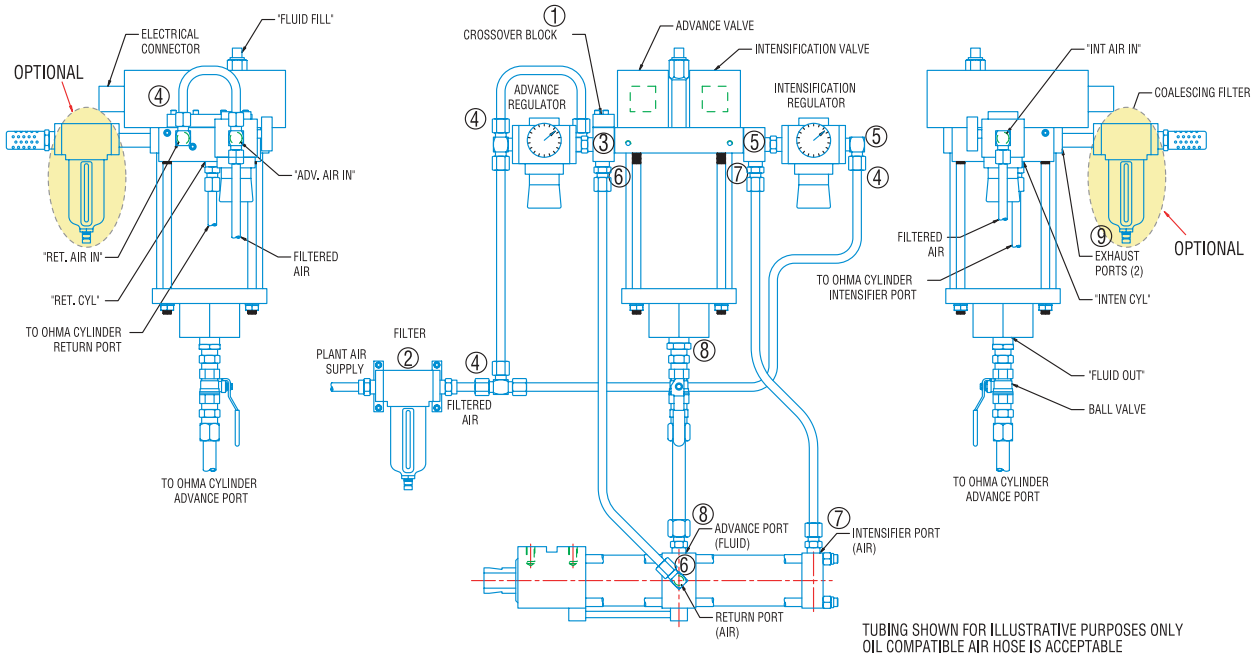

OHMA® Piercing Cylinders feature a superior sealing system that assures outstanding performance. Due to our close manufacturing tolerances, new cylinder applications that operate below 60 psi will require a break-in period to help reduce the cylinder's internal seal friction. Please consult with CenterLine's Automation Components Division for required break-in period operating instructions for any application operating below 60 psi.

- 1 Remove the CROSSOVER BLOCK, invert it and re-install.
- 2 Connect the PLANT AIR SUPPLY to the inlet port of a FILTER which is sized for the system.
- 3 Connect the ADVANCE REGULATOR to the "ADV. AIR IN" port on the fluid reservoir.
- 4 Tee the outlet port from the FILTER to the "RET. AIR IN" port and the ADVANCE REGULATOR (for Delicate Touch option if applicable) on the fluid reservoir. Also, tee the outlet port from the FILTER to the INTENSIFICATION REGULATOR.
- 5 Connect the INTENSIFICATION REGULATOR to the "INT AIR IN" port on the fluid reservoir.
- 6 Connect the "RET.CYL" port on the fluid reservoir to the OHMA® cylinder RETURN PORT (AIR).
- 7 Connect the "INTEN CYL" port on the fluid reservoir to the OHMA® cylinder INTENSIFIER PORT (AIR).
- 8 Connect the "FLUID OUT" port on the fluid reservoir to the OHMA® cylinder ADVANCE PORT (FLUID).
- 9 Finally, put mufflers on the EXHAUST PORTS (2) of the fluid reservoir.

Items shown in blue apply only to the "Delicate Touch" option reservoir hook-up.

NOTE: Use of hydraulic fittings will restrict fluid flow to the cylinder. Since the fluid pressure in the hose/tubing is not above the system air pressure supplied by the user, standard air fittings should be used.

The OHMA® Cylinder is a patented product. CenterLine (Windsor) Limited reserves the right to change specifications.

PIERCING CYLINDER HOOK-UP

Pneumatic Schematics

Standard Hook-up

The **standard hook-up** schematic outlines the basic system requirements needed to operate the OHMA® Piercing cylinder. In this configuration, one regulator is used to control air pressure that is fed to the INTENSIFICATION VALVE (cylinder intensify) and full line air pressure is supplied to the ADVANCE VALVE to advance and retract the cylinder. Regulating the intensification pressure allows the user to adjust the force output of the cylinder without compromising low pressure advance and return speeds. An optional **pressure switch** is used to verify that intensification air pressure is present. A pressure transducer may be used to check that the intensification is above a minimum level and below a maximum level. The schematic assumes the use of the OHMA® ISO or ASB style fluid reservoir package. This approach may be used with a fluid reservoir and remote valve package.

Delicate Touch Hook-up

The **delicate touch hook-up** option includes a regulator (2) at the position shown. Full line pressure is used to retract the cylinder. The simplicity of the OHMA® cylinder's method of operation allows for alternate hook-up configurations as required by the application, including multiple intensification strokes & programmable air pressure settings. Contact CenterLine to obtain information on how to maximize cylinder performance through alternate hook-up configurations.

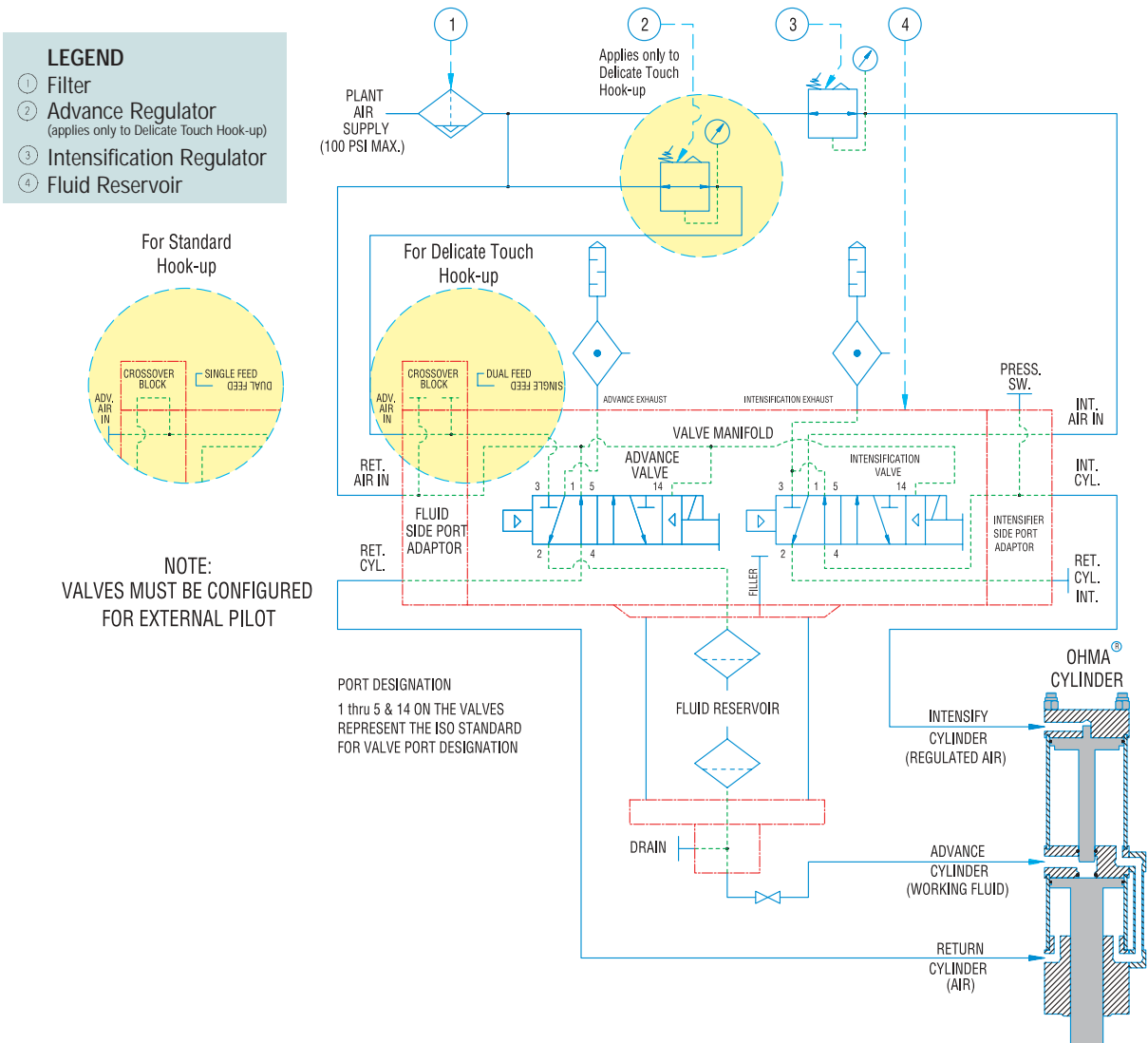

The OHMA® Cylinder is a patented product. CenterLine (Windsor) Limited reserves the right to change specifications.

PIERCING CYLINDERS

Operating Instructions, Unique Cylinder Style & Options

OPERATING INSTRUCTIONS

To ensure proper cylinder performance, the following instructions should be observed:

Service Connection

For all lines use oil compatible air hose or low pressure hydraulic tubing. To select the proper hosing or tube size, both the cylinder and fluid reservoir port size must be considered. Normally, reservoir port sizes will dictate minimum line size. Consult the "Dimensional Specifications" charts and the fluid reservoir section (section C) to obtain this information.

For all ports use either brass or steel fittings which are free of rust and dirt. **Hydraulic fittings are not recommended for use with the OHMA® cylinder as they restrict the flow of fluid resulting in slower cylinder operation. Fitting ID's should be as large as possible to maximize fluid and air flow to the cylinder. For air lines, maximum length of line should not exceed 20 feet; fluid lines should not extend beyond 10 feet in length.**

Additional instructions dealing with piping of the cylinder to the fluid reservoir are contained in the reservoir section of this brochure (section C).

Electrical Hook-up

Contact CenterLine to receive a standard electrical schematic of typical hook-up configurations. Applications requiring the use of pressure switches, limit switches and blocking valves should first be discussed with CenterLine to ensure proper placement within the system configuration.

Cylinder Mounting

The cylinder may be mounted in any orientation, however, **the fluid line leaving the cylinder should travel upward toward the fluid reservoir at all times. Failure to comply with this condition may result in loss of output force as a result of air being trapped in the**

lines feeding the OHMA® cylinder.

By following this simple rule any air introduced to the system will naturally return to the reservoir and be bled from the system.

The tooling should be mounted so that the work is performed at the center of the rod. Offset loads may result in premature wear to the seals or nose bushing. The tooling weight must be within the allowable return force range for the cylinder. Consult the "Dimensional Specifications" charts for return force specifications.

Position the work so that the cylinder does not bottom out during the advance or the power stroke. This operating principle applies to all cylinder models. The OHMA® cylinder will produce a consistent force and power stroke as long as the part is positioned within the cylinder's advance stroke range.

The OHMA® cylinder should be cycled several times after installation to remove any air trapped in the cylinder from the installation process. If air remains trapped in the lines, the cylinder may be bled using the bleeder. (NOTE: some OHMA® cylinders do not have bleeders, consult with CenterLine for additional instructions.) To use this bleeder, slowly loosen off the bleeder screw and wait until the fluid flowing from the bleeder contains no additional air. Tighten the bleeder and then cycle the cylinder and confirm that proper force is being generated.

General Guidelines

Never strike the barrel or rod to align the cylinder. **Any modifications to the cylinder should first be discussed with CenterLine**

The cylinder should be operated in a clean environment. If the cylinder is removed from operation, seal all ports immediately upon removal.

OHMA® WELD CYLINDERS

In addition to the OHMA® Piercing Cylinders, CenterLine also manufactures a complete line of welding cylinders. The OHMA® Welding Cylinders are available in a variety mounting styles including:

- Rear-Hairpin
- Stud Mount
- Flange and Front Block Mounts
- Pivot Style Mounts (for weld gun requirements)



These cylinders are ideally suited for fixture, press, and weld gun applications requiring small bore, high force, welding cylinders. The low impact approach brings numerous benefits to weld applications including, prolonged electrode life, minimal part deformation and consistent electrode alignment. The unique operation of the OHMA® cylinder minimizes weld expulsion and produces constant weld force for superior weld quality. Contact CenterLine to receive additional information about the OHMA® Welding Cylinders.

VARIED APPLICATIONS

Thousands of standard and custom OHMA® cylinders are in use performing applications found in the **automotive, appliance, plastics, and aerospace** industries. From installing self-pierce nuts to coining intricate designs in jewelry, applications requiring a consistent working force over a short distance will benefit from making use of the OHMA® cylinder.

The OHMA® cylinders are ideal for stationary self-equalizing pierce units and are a truly viable alternative to many hydraulic, pneumatic and mechanical systems.

With the OHMA® cylinder... **your imagination is the only limit.**



The OHMA® Cylinder is a patented product. CenterLine (Windsor) Limited reserves the right to change specifications.

UNIQUE CYLINDER STYLE & OPTIONS

Special applications can be satisfied with custom manufactured or modified OHMA® cylinders.

CUSTOM CYLINDER STYLES

CenterLine can supply custom cylinders to overcome application problems such as:

- limited operating space
- special force and work stroke requirements
- specific mounting and tooling needs

The OHMA's straightforward design makes it possible to manufacture custom styles while maintaining basic operating principles. All custom cylinders are designed with as many standard components as is practical so that replacement parts are available from stock. CenterLine application engineers can recommend complete system solutions for nearly any application condition.



SPECIAL MODIFICATIONS

Modifications to standard OHMA® cylinder styles are available to satisfy particular tooling and machine designs.

Modifications include:

- threaded, grooved, or tapered piston rods
- changes to port locations
- modified stroke lengths
- mounting block alterations

CenterLine maintains a small stock of partially machined piston rods and mounting blocks to satisfy emergency needs for special cylinders. Modifications are also available to reservoirs and press frames.



OHMA® BOOSTER CYLINDERS

Booster/Air cylinder combination separates the two halves of the OHMA® cylinder

- Possible solution for longer high pressure strokes or space limitations where a standard cylinder will not fit
- An external high pressure line must be installed and maintained

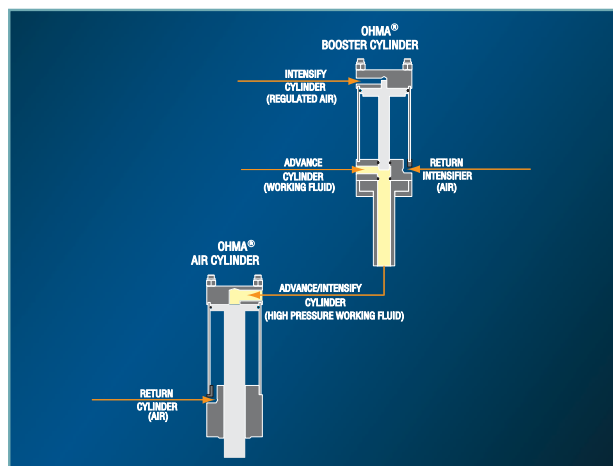



CenterLine (Windsor) Limited

Automation Components Division
655 Morton Drive
Windsor, ON N9J 3T9 Canada

U.S.A.:

P.O. Box 321187, Detroit, MI 48232-1187 U.S.A.

Can: (519) 734-8330

U.S.: (313) 961-3731

Toll Free: 1-800-268-8330

www.cntrline.com